

OPERATION AND SERVICE MANUAL

8569A SPECTRUM ANALYZER

0.01 — 40 GHz
OPTION 001/002

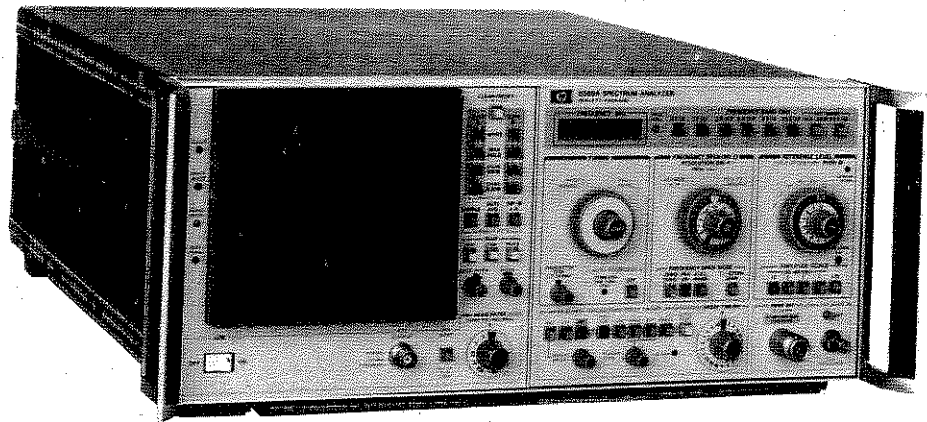

volume 1

GENERAL INFORMATION
INSTALLATION AND OPERATION VERIFICATION
OPERATION



**HEWLETT
PACKARD**



**HEWLETT
PACKARD**

OPERATION AND SERVICE MANUAL

**8569A
SPECTRUM ANALYZER
Includes Options 001 and 002**

SERIAL NUMBERS

This manual applies directly to HP Model 8569A Spectrum Analyzer having serial prefix number 2045A.

For additional important information about serial numbers see INSTRUMENTS COVERED BY MANUAL in Section I.

volume 1 GENERAL INFORMATION
INSTALLATION AND OPERATION VERIFICATION
OPERATION

Copyright © 1981, HEWLETT-PACKARD COMPANY
1400 FOUNTAIN GROVE PARKWAY, SANTA ROSA, CALIFORNIA, 95404, U.S.A.

MANUAL PART NO. 08569-90001

Printed: March 1981

TABLE OF CONTENTS

Section	Page	Section	Page
I		GENERAL INFORMATION	1-1
	1-1.	Introduction	1-1
	1-3.	Description	1-1
	1-9.	Manual Organization	1-1
	1-11.	Specifications	1-2
	1-13.	Safety Considerations	1-2
	1-18.	Instruments Covered by Manual	1-3
	1-27.	Options	1-4
	1-40.	Accessories Supplied	1-4
	1-42.	Equipment Available	1-4
	1-49.	Recommended Test Equipment	1-4
II		INSTALLATION AND OPERATION	
		VERIFICATION	2-1
	2-1.	Introduction	2-1
		2-3. Initial Inspection	2-1
		2-5. Preparation for Use	2-1
		2-25. Storage and Shipment	2-7
		2-31. Operation Verification	2-7
		2-33. Operational Check	2-8
		2-34. Tuning Accuracy	2-11
		2-35. Frequency Span Width and Resolution Bandwidth Accuracy	2-13
		2-36. Amplitude Accuracy	2-15
III		OPERATION	3-1
		3-1. Introduction	3-1
		3-4. Routine Maintenance	3-1

LIST OF ILLUSTRATIONS

Figure	Page	Figure	Page
1-1.		HP Model 8569A Spectrum Analyzer with Accessories Supplied	1-0
1-2.		Typical Serial Number Plate	1-3
1-3.		Service Accessories Package	1-12
2-1.		Line Voltage Selection with Power Module PC Board	2-4
2-2.		Attaching Rack Mounting Hardware and Handles	2-5
2-3.		Packaging for Shipment Using Factory Packaging Materials	2-6
2-4.		Operation Verification Test Setup	2-12
2-5.		Span Width Accuracy Measurement	2-15

LIST OF TABLES

Table	Page	Table	Page
1-1.		HP Model 8569A Specifications	1-5
1-2.		HP Model 8569A Supplemental Characteristics	1-8
1-3.		Recommended Test Equipment	1-14
2-1.		AC Power Cables Available	2-2
2-2.		Rack-Mounting Kits for HP 8569A	2-3
2-3.		Operational Check	2-9
2-4.		Operation Verification Test Record	2-17

HP 8569A

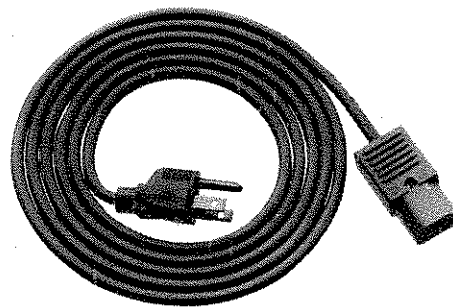
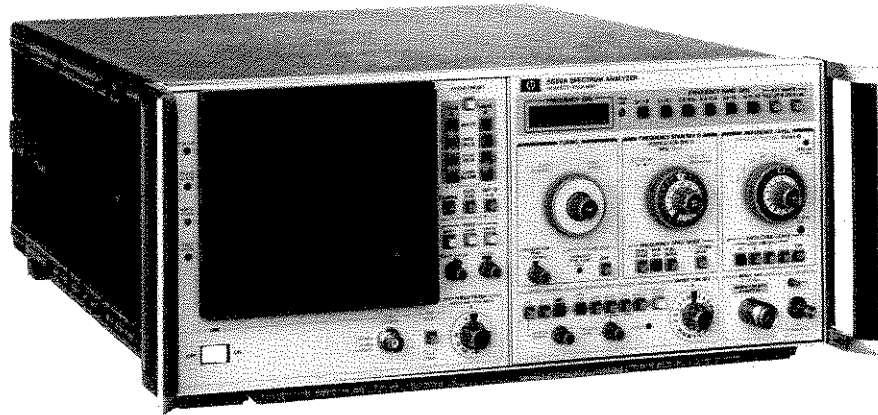

LINE POWER CABLE

(SEE TABLE 2-1 FOR
HP PART NUMBER)

Figure 1-1. HP Model 8569A Spectrum Analyzer with Accessories Supplied

SECTION I GENERAL INFORMATION

1-1. INTRODUCTION

1-2. This Operation and Service manual contains information required to install, operate, test, adjust, and service the Hewlett-Packard Model 8569A Spectrum Analyzer. Figure 1-1 shows the instrument and accessories supplied. This section covers instrument identification, description, options, accessories, specifications, and other basic information.

1-3. DESCRIPTION

1-4. The HP Model 8569A Spectrum Analyzer provides a visual display of RF and microwave signals in the frequency domain. Input signal amplitude is plotted on the CRT as a function of frequency.

1-5. The HP Model 8569A is designed for simplicity of operation. Most measurements can be made using only three controls, once the normal settings (marked in green) have been preset. The HP Model 8569A has absolute amplitude and frequency calibration from 10 MHz to 22 GHz. The frequency span, bandwidth, and video filter are all coupled with automatic sweep time to maintain a calibrated display and to simplify operation of the analyzer.

1-6. Internal preselection eliminates most spurious images and multiple responses to simplify signal identification. The preselector also extends dynamic range of the analyzer and provides some protection for the input mixer.

1-7. The frequency range of the HP Model 8569A is 10 MHz to 22 GHz in direct coaxial input and 14.5 to 40 GHz when used with the HP Model 11517A External Mixer.

1-8. The HP Model 8569A has a digital display with the spectral information contained in either of two independent traces. Major control settings are annotated on the CRT above the graticule area. Signal processing controls for the digital display include trace normalization, a maximum hold function, digital averaging, and trace storage. A hard-copy record of the display may be obtained

through direct instrument control of listen-only plotters. The HP Model 8569A has an HP-IB capability that allows controller interrogation of display information or controller entry of messages and trace data.

1-9. MANUAL ORGANIZATION

1-10. This manual is divided into eight sections as follows:

SECTION I, GENERAL INFORMATION, contains the instrument description and specifications, explains accessories and options, and lists recommended test equipment.

SECTION II, INSTALLATION AND OPERATION VERIFICATION, contains information concerning initial mechanical inspection, preparation for use, operating environment, packaging and shipping, and operation verification.

SECTION III, OPERATION, contains detailed operating instructions for operation of the instrument.

SECTION IV, PERFORMANCE TESTS, contains the necessary tests to verify that the electrical operation of the instrument is in accordance with published specifications.

SECTION V, ADJUSTMENTS, contains the necessary adjustment procedures to properly adjust the instrument after repair.

SECTION VI, REPLACEABLE PARTS, contains the information necessary to order parts and/or assemblies for the instrument.

SECTION VII, MANUAL BACKDATING CHANGES, contains backdating information to make this manual compatible with earlier equipment configurations.

SECTION VIII, SERVICE, contains schematic diagrams, block diagrams, component location illustrations, circuit descriptions, and troubleshooting information to aid in repair of the instrument.

1-11. SPECIFICATIONS

1-12. Instrument specifications are listed in Table 1-1. These specifications are the performance standards or limits against which the instrument is tested. Table 1-2 lists supplemental characteristics. Supplemental characteristics are not specifications but are typical characteristics included as additional information for the user.

NOTE

To ensure that the HP Model 8569A meets the specifications listed in Table 1-1, performance tests (Section IV) should be performed every six months.

1-13. SAFETY CONSIDERATIONS

1-14. Before operating this instrument, you should familiarize yourself with the safety markings on the instrument and safety instructions in this manual. This instrument has been manufactured and tested according to international safety standards. However, to ensure safe operation of the instrument and personal safety of the user and service personnel, the cautions and warnings in this manual must be followed. Refer to page 1-1 for summary of safety considerations. Refer also to individual sections of this manual for detailed safety notation concerning the use of the instrument as described in those individual sections.

1-15. Safety Symbols



Instruction manual symbol: the apparatus will be marked with this symbol when it is necessary for the user to refer to the instruction manual in order to protect the apparatus against damage.



Indicates dangerous voltages.



Earth terminal

WARNING

The WARNING sign denotes a hazard. It calls attention to a procedure, practice, or the like, which, if not correctly performed or adhered to, could result in injury or loss of life. Do not proceed beyond a WARNING sign until the indicated conditions are fully understood and met.

CAUTION

The CAUTION sign denotes a hazard. It calls attention to an operating procedure, practice, or the like, which, if not correctly performed or adhered to, could result in damage to or destruction of part or all of the equipment. Do not proceed beyond a CAUTION sign until the indicated conditions are fully understood and met.

1-16. Service

1-17. Although this instrument has been manufactured in accordance with international safety standards, this manual contains information, cautions, and warnings which must be followed to insure safe operation and to keep the instrument safe. Service should be performed only by qualified service personnel, and the following warnings should be observed:

WARNINGS

Any maintenance or repair of the opened instrument under voltage should be avoided as much as possible, and when inevitable, should be carried out only by a skilled person who is aware of the hazard involved.

Capacitors inside the instrument may still be charged even if the instrument has been disconnected from its source of supply.

Make sure that only fuses with the required rated current and of the specified type (normal blow, time delay, etc.) are used for replacement. The use of repaired fuses and the short-circuiting of fuseholders must be avoided.

When it is likely that the protection has been impaired, the instrument must be made inoperative and be secured against any unintended operation.

If this instrument is to be energized via an auto-transformer (for voltage reduction) make sure the common terminal is connected to the earthed pole of the power source.

BEFORE SWITCHING ON THE INSTRUMENT, the protective earth terminals of the instrument must be connected to the protective conductor of the mains power cord. The mains plug shall only be inserted in a socket outlet provided with a protective earth contact. The protective action must not be negated by the use of an extension cord (power cord) without a protective conductor (grounding). Grounding one conductor of a two conductor outlet is not sufficient protection.

Any interruption of the protective (grounding) conductor (inside or outside the instrument) or disconnecting the protective earth terminal is likely to make this instrument dangerous.

CAUTIONS

BEFORE SWITCHING ON THIS INSTRUMENT, make sure instrument's ac input is set to the voltage of the ac power source (see Figure 2-1).

BEFORE SWITCHING ON THIS INSTRUMENT, make sure the ac line fuse is of the required current rating and type (normal-blow, time delay, etc.).

1-18. INSTRUMENTS COVERED BY MANUAL

1-19. Serial Numbers

1-20. Attached to the rear of each section of your instrument is a serial number plate (Figure 1-2). The serial number is in two parts. The first four digits and letter are the serial number prefix; the last five digits are the suffix. The prefix is the same for all identical instruments; it changes only when a change is made to the instrument. The suffix, however, is assigned sequentially and is different for each instrument. The contents of this manual apply to instruments with the serial number prefix-(es) listed under SERIAL NUMBERS on the title page.

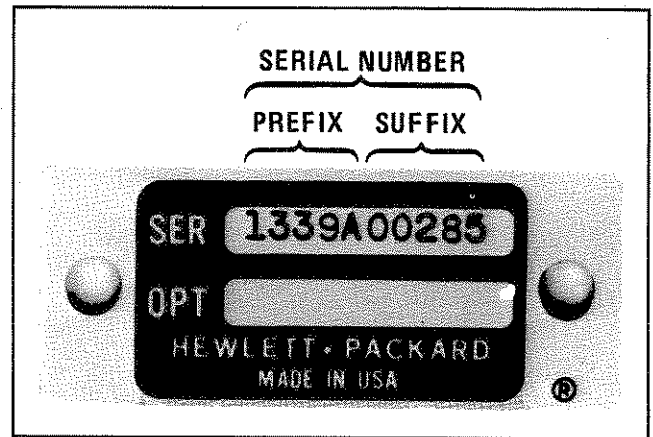

Figure 1-2. Typical Serial Number Plate

1-21. Manual Changes Supplement

1-22. An instrument manufactured after the printing of this manual may have a serial number prefix that is not listed on the title page. This unlisted serial number prefix indicates the instrument is different from those described in this manual. The manual for this newer instrument is accompanied by a yellow Manual Changes supplement. This supplement contains 'change information' that explains how to adapt the manual to the newer instrument.

1-23. In addition to change information, the supplement may contain information for correcting errors in the manual. To keep this manual as current and accurate as possible, Hewlett-Packard recommends that you periodically request the latest Manual Changes supplement. The supplement carries a manual identification block that includes the model number, print date of the manual, and manual part number. Complimentary copies of the supplement are available from Hewlett-Packard. Addresses of Hewlett-Packard offices are located at the back of this manual.

1-24. Manual Backdating Changes

1-25. Instruments manufactured before the printing of this manual have been assigned serial number prefixes other than those for which this manual was written directly. Manual backdating information is provided in Section VII to adapt this manual to any such earlier assigned serial number prefix.

1-26. This information should not be confused with information contained in the yellow Manual Changes Supplement, which is intended to adapt

this manual to instruments manufactured after the printing of this manual.

1-27. OPTIONS

1-28. Option 001

1-29. Option 001 provides an internally connected, 100-MHz comb generator that is switched in by a front-panel pushbutton.

1-30. Option 002

1-31. Option 002 deletes the two most narrow RESOLUTION BW settings, .3 kHz and .1 kHz, provided on the standard instrument.

1-32. Option 400

1-33. Option 400 permits operation on 50, 60, and 400 Hz mains. All specifications are identical to those of the standard HP Model 8569A except for operating temperature range and power requirements (see Table 1-1).

1-34. Option 908, Rack Flange Kit

1-35. Option 908, HP Part Number 5061-0078, includes flanges and hardware required to mount the HP Model 8569A in an equipment rack with horizontal spacing of 482.6 mm (19 in.). See Figure 2-2 for installation procedure.

1-36. Option 913, Rack Flange/Front Handle Kit

1-37. Option 913, HP Part Number 5061-0084, combines a Front Handle Kit with Option 908, Rack Flange Kit. See Figure 2-2 for installation procedure.

1-38. Option 910, Additional Operation and Service Manual.

1-39. One additional Operation and Service Manual is provided for each Option 910 ordered.

To obtain Option 910 after shipment of the instrument, specify the manual part number printed on the title page of the manual.

1-4

1-40. ACCESSORIES SUPPLIED

1-41. Figure 1-1 shows the HP Model 8569A Spectrum Analyzer and line power cord. Two 50-ohm terminations (HP Model 11593A) are also supplied. One termination is connected to the front-panel EXT MIXER port and the other, to the rear-panel 1st LO OUTPUT port.

1-42. EQUIPMENT AVAILABLE

1-43. Service Accessories

1-44. A Service Accessories Package is available for convenience in aligning and troubleshooting the spectrum analyzer. The Service Accessories Package is shown in Figure 1-3. The package may be obtained from Hewlett-Packard by ordering HP Part Number 08569-60035.

1-45. Measurement Accessories

1-46. **HP Model 11517A External Mixer.** This mixer extends the frequency range of the HP Model 8569A to 40 GHz. Transition sections (HP Models 11518, 11519A, and 11520A) are available to adapt the HP Model 11517A External Mixer to standard waveguide sizes.

1-47. **HP Model 197A, Option 006 Oscilloscope Camera.** This camera can be used with the Model 8569A to make a permanent record of measurements.

1-48. **HP Model K01-8569A Transit Case.** This case protects the 8569A and provides a storage compartment for cables and reference material.

1-49. RECOMMENDED TEST EQUIPMENT

1-50. Equipment required for operation verification, performance tests, adjustments, and troubleshooting of the HP Model 8569A is listed in Table 1-3. Other equipment may be substituted if it meets or exceeds the critical specifications listed in the table.

Table 1-1. HP Model 8569A Specifications (1 of 3)

SPECIFICATIONS

FREQUENCY SPECIFICATIONS

FREQUENCY RANGE

Internal mixer 0.01 to 22 GHz

Covered in six ranges selectable by Frequency Band pushbuttons (in GHz): .01 to 1.8; 1.7 to 4.1; 3.8 to 8.5; 5.8 to 12.9; 8.5 to 18; 10.5 to 22.

External mixer, HP 11517A, Opt. E03, 14.5 to 40 GHz

Covered in two ranges selectable by Frequency Band pushbuttons (in GHz): 14.5 to 26.6 (6+ harmonic mode); 22.9 to 40 (10+ harmonic mode).

FREQUENCY ACCURACY

Tuning Accuracy

The overall tuning accuracy of the digital frequency readout in any span mode:

Internal mixing

$\pm(5 \text{ MHz or } 0.2\% \text{ of center frequency, whichever is greater, } +20\% \text{ of frequency span per division})$

External mixing

$\pm(0.7\% \text{ of center frequency } +20\% \text{ of frequency span per division})$

CRT digital readout resolution (included in tuning accuracy)

Internal mixing, 100 kHz; external mixing, 1 MHz

FREQUENCY SPANS

(on a 10 division CRT horizontal axis)**1.7 to 22 GHz**

Multiband span of spectrum from 1.7 to 22 GHz in one sweep. The frequency (position) corresponding to the tuning marker is set by the Tuning control and indicated by the digital frequency displays on the front panel and the CRT.

Full Band

Displays spectrum of entire Frequency Band selected. Tuning marker displayed in Full Band mode (becomes center frequency when Per Division mode is selected). Marker frequency is given on the digital displays.

Per Division

Eighteen calibrated spans from 1 kHz/Div to 500 MHz/Div in a 1, 2, 5, 10 sequence. In "F" position the entire Frequency Band selected is spanned.

Span width accuracy

The frequency error for any two points on the display for spans from 500 MHz to 20 kHz/Div (unstabilized) is less than $\pm 5\%$ of the indicated separation; for stabilized spans 100 kHz/Div and less, the error is less than $\pm 15\%$.

Center Frequency

The center frequency represented by the CRT is indicated by the digital frequency displays on the front panel and the CRT.

Zero Span

Analyzer becomes a manually tuned receiver (for the time domain display of signal modulation) set to the frequency indicated by the digital frequency displays.

SPECTRAL RESOLUTION AND STABILITY

Resolution Bandwidths

Resolution (3 dB) bandwidths from .1 kHz to 3 MHz in 1, 3 sequence. Bandwidth may be varied independently or coupled to Frequency Span/Div control. Optimum coupling (convenient ratio of Frequency Span/Div to Resolution Bandwidth) is indicated by alignment of markers ($\blacktriangleright\blacktriangleleft$) on both controls.

Uncoupled, the controls for Frequency Span/Div and Resolution Bandwidth may be independently set so any resolution bandwidth (3 MHz to .1 kHz) may be used with any span width (F and 500 MHz to 1 kHz/Div). Analyzer is calibrated if UNCAL is not displayed.

Resolution Bandwidth accuracy

Individual resolution bandwidth 3 dB points:

$< \pm 15\%$.

Selectivity: (60 dB/3 dB bandwidth ratio) $< 15:1$ for bandwidths 3 kHz to 3 MHz; $< 11:1$ for bandwidths .1 kHz to 1 kHz.

Stability**Total residual FM**

Stabilized: $< 100 \text{ Hz p-p in } 0.1 \text{ sec, } .01 - 4.1 \text{ GHz}$

Unstabilized: $< 10 \text{ kHz p-p in } 0.1 \text{ sec, } .01 - 4.1 \text{ GHz}$
(Fundamental mixing)

Stabilization range: First LO automatically stabilized (unless auto stabilizer is OFF) for frequency spans 100 kHz/Div or less.

Noise sidebands: At least 75 dB down, greater than 30 kHz from center of CW signal when set to a 1 kHz Resolution Bandwidth and a 10 Hz (.01) Video Filter (fundamental mixing).

Video Filter

Post detection low-pass filter used to average displayed noise for a smooth trace. Nominal settings are given as decimal fractions of the Resolution Bandwidth: OFF, .3, .1, .03, .01, and .003. A 1 Hz NOISE AVG (noise averaging) setting is provided for noise level measurement.

AMPLITUDE SPECIFICATIONS

AMPLITUDE RANGE — Internal mixer

(Amplitude specifications for the HP 8569A Spectrum Analyzer with the HP 11517A, Opt. E03, External Mixer are given near the end of Table 1-1.)

Measurement range:**Damage levels:**

Total RF power: +30 dBm (1 watt)

dc or ac ($<< 50\Omega$ source impedance):

0V with 0 dB input attenuation (1 amp); $\pm 7\text{V}$

with $\geq 10 \text{ dB}$ input attenuation (0.14 amp)

Table 1-1. HP Model 8569A Specifications (2 of 3)

Peak pulse power:

+50 dBm (<10 μ sec. pulse width, 0.01% duty cycle), \geq 20 dB attenuation

Gain compression:

< 1 dB for -7 dBm input level with 0 dB attenuation.

Average noise level:

Sensitivity (minimum discernible signal) is given by the signal level which is equal to the average noise level, causing approximately a 3 dB peak above the noise. Maximum average noise level with 1 kHz Resolution Bandwidth (0 dB attenuation and 0.003 (3 Hz) video filter) is given in the table below:

Frequency Band (GHz)	First IF in MHz	Harmonic Mode	Avg. Noise Level (dBm)
.01-1.8	2050	1-	-113
1.7-4.1	321.4	1-	-110
3.8-8.5	321.4	2-	-107
5.8-12.9	321.4	3-	-100
8.5-18	321.4	4+	-95
10.5-22	321.4	5+	-90

Reference Level

Reference Level range: +60 dBm¹ to -112 dBm in 10 dB steps and continuous 0 to -12 dB calibrated vernier.

Reference Level accuracy:

With Sweep Time/Division control in Auto setting, the optimum sweep rate is selected automatically for any combination of Frequency Span/Div, Resolution Bandwidth and Video Filter settings. Thus, the Auto Sweep setting insures a calibrated amplitude display within the following limits:

Calibrator output

-10 dBm \pm 0.3 dB
100 MHz \pm 10 kHz

Reference Level variation (Input Attenuator at 0 dB)

10 dB steps, +20°C to +30°C:
-10 to -70 dBm: $< \pm$ 0.5 dB
-10 to -100 dBm: $< \pm$ 1.0 dB
-10 to -70 dBm: $< \pm$ 1.0 dB, 0°C to +55°C

Vernier (0 to -12 dB) continuous: Maximum error $< \pm$ 0.5 dB, when read from Reference Level Fine control.

Input Attenuator (at preselector input, 70 dB range in 10 dB steps)

Step size variation:

0 to 60 dB, 0.01-18 GHz: $< \pm$ 1.0 dB
0 to 40 dB, 0.01-22 GHz: $< \pm$ 1.5 dB

Maximum cumulative error:

0 to 60 dB, 0.01-18 GHz: $< \pm$ 2.4 dB
0 to 40 dB, 0.01-22 GHz: $< \pm$ 2.5 dB

Frequency Response (with 0 or 10 dB of Input Attenuation)

Frequency response includes input attenuator, preselector and mixer frequency response plus mixing mode gain variation (band to band) and assumes preselector peaking.

Frequency Band (GHz)	Frequency Response (\pm dB MAX.)
.01-1.8	1.2
1.7-4.1	1.5
3.8-8.5	2.5
5.8-12.9	2.5
8.5-18	3.0
10.5-22	4.5

Switching between bandwidths: 3 MHz to 300 kHz, $< \pm$ 0.5 dB; 3 MHz to 0.1 kHz, $< \pm$ 1.0 dB.

Calibrated display range

Log expanded from reference level down:

70 dB with 10 dB/Div scale factor
40 dB with 5 dB/Div scale factor
16 dB with 2 dB/Div scale factor
8 dB with 1 dB/Div scale factor

Linear: Full scale from 0.56 μ V (-112 dBm across 50 ohms to 224 volts (+60 dBm)¹ in 10 dB steps and continuous 0 to -12 dB vernier. Full scale signals in linear translate to approximately full scale signals in the log modes.

Display accuracy

Log: $< \pm$ 0.1 dB/dB but not more than \pm 1.5 dB over 70 dB display range.
Linear: $< \pm$ 3% over full 8 division deflection

Residual responses (no signal present at input):

With 0 dB input attenuation and fundamental mixing (0.01 to 4.1 GHz): < -90 dBm.

Signal Identifier:

Provided over entire frequency range and in all Frequency Span/Div. settings. Correct response is a 2 MHz shift to left and approximately a 6 dB lower amplitude. (Reads incorrectly for 100 MHz CAL OUTPUT Signal.)

SWEEP SPECIFICATIONS

SWEEP TIME

Auto: Sweep time is automatically controlled by Frequency Span/Div, Resolution Bandwidth and Video Filter controls to maintain an absolute amplitude calibrated display.

Calibrated Sweep times: 21 internal sweep times from 2 μ sec/Div to 10 sec/Div in 1, 2, 5 sequence. Sweep time accuracy \pm 10% except for 2, 5, and 10 sec/Div, which are \pm 20%. Swept frequency modes use sweep times 2 msec/Div through 10 sec/Div. When operated as a fixed tuned receiver (Zero Span) the full range of sweep times (2 μ sec to 10 sec/Div) may be used to display modulation waveforms. Sweep times that are too fast or too slow for the Resolution Bandwidth, Frequency Span/Div, and Video Filter settings (producing an uncalibrated display) are indicated by an UNCAL warning on the CRT. Sweep times \leq 2 msec/Div (\leq msec/Div when in Max Hold, Digital Averaging, or INP-B—A Normalization) produce a mixed mode display with analog traces and CRT control readouts on the CRT.

¹ Input level not to exceed +30 dBm damage level.

Table 1-1. HP Model 8569A Specifications (3 of 3)

GENERAL SPECIFICATIONS**TEMPERATURE RANGE:**

Operating 0°C to 55°C
Storage -40°C to +75°C.

HUMIDITY RANGE (Operating):

< 95% R.H. 0°C to +40°C.

EMI:

Conducted and radiated interference is in compliance with MID-STD 461A Methods CEO3 and REO2, CISPR publication 11 (1975) and Messempefaenger- Postverfuegung 526/527/79 (Kennzeichnung Mit F- Nummer/Funkschutzzeichen).

POWER REQUIREMENTS

48-66 Hz, 100, 120, 200 or 240 volts (-10% to +5%); 220 VA maximum. Fan cooled.

DIMENSIONS

458 mm wide; 188 mm high, 565 mm deep (18 in. x 7 3/8 in. x 22 1/4 in.)

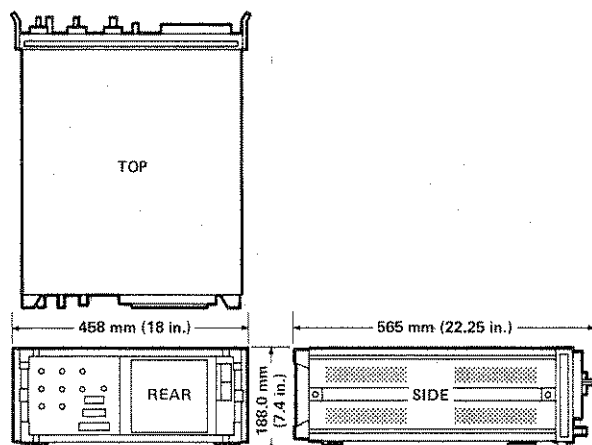
**WEIGHT:**

Net: 29.1 kg (64 lbs.)
Shipping: 40.9 kg (90 lbs.)

11517A, Opt. E03 EXTERNAL MIXER

When used with the HP 8569A for operation in waveguide 14.5 to 40 GHz:

MEASUREMENT RANGE

Maximum waveguide input: Saturation (gain compression < 1 db), -15 dBm; Damage Level > 0 dBm or 0.1 erg.

Sensitivity:

(Average noise level in a 10 kHz IF bandwidth)

14.5-18 GHz < -80 dBm

18-26.5 GHz < -70 dBm

26.5-40 GHz < -60 dBm

Typical sensitivity is 10 dB better for each band.

STANDARD OPTIONS AVAILABLE**OPTION 001****Comb Generator**

Frequency Accuracy: $\leq \pm 0.005\%$

OPTION 002

Deletes .3 kHz and .1 kHz resolution BW settings.

All specifications identical to standard HP 8569A except:

Spectral Resolution and Stability

Resolution Bandwidths: Resolution (3 dB) bandwidths from 1 kHz to 3 MHz in a 1, 3 sequence.

Selectivity: (60 dB/3 dB bandwidth ratio) < 15:1 for bandwidths 1 kHz to 3 MHz.

Stability**Total Residual FM**

Stabilized: < 200 Hz p-p in 0.1 sec. .01-8.5 GHz

OPTION 400, 400 Hz POWER SUPPLY

Permits operation on 50, 60, or 400 Hz mains.

All specifications identical to standard HP 8569A except:

GENERAL SPECIFICATIONS

Temperature range (operating): 50-60 Hz 0°C to 40°C
400 Hz 0°C to 55°C

Power requirements: 50, 60, or 400 Hz; 100, 120, 200, or 240 volts (-10% to +5%); 220 VA, maximum. Fan cooled.

¹Input level not to exceed +137 dB μ V damage level.

Table 1-2. HP Model 8569A Supplemental Characteristics (1 of 4)

SUPPLEMENTAL CHARACTERISTICS

NOTE: Values in this table are not specifications but are typical characteristics included for user information.

FREQUENCY CHARACTERISTICS

FREQUENCY SPANS

1.7 to 22 GHz

When this mode is selected the analyzer displays the entire spectrum from 1.7 to 22 GHz. A 3 MHz Resolution Bandwidth, 9 kHz Video Filter, and 100 msec/div Sweep Time are automatically selected.

Full Band

When selected by panel pushbutton, analyzer displays spectrum of Frequency Band chosen. This automatically selects a 3 MHz Resolution bandwidth and a 9 kHz Video Filter. Sweep Time/Div varies from approximately 10 msec to 100 msec/div depending on which Frequency Band is chosen. Tuning marker frequency (position) indicates where analyzer tuning will be centered if a Per Division span mode is chosen.

Per Division

In "F" position (full band), the entire range of the Frequency Band selected is spanned, thus allowing the use of Resolution Bandwidth and Video Filter settings other than those chosen when the Full Band pushbutton is depressed. Center frequency of the analyzer's display is set by the tuning control and indicated by the LED readouts. The Frequency CAL control to the right of the display window on the front panel is used to set the LED readout to agree with the actual center frequency of the CRT display (normally set using the 100 MHz CAL OUTPUT as a 0.100 GHz frequency reference).

Out-of-range blanking

The out-of-range portion of the CRT trace is automatically blanked whenever the analyzer is swept beyond a band edge.

RESOLUTION

Bandwidth Ranges

See Figure 1 for curves of typical analyzer resolution using different IF bandwidths.

IF Bandwidth shape:

Approximately gaussian (synchronously tuned, 4-pole filter)

Frequency drift (fundamental mixing, .01-4.1 GHz) long term

At fixed center frequency after 2 hours warm-up:

- Stabilized < ± 3.0 kHz/10 minutes
- Unstabilized < ± 25 kHz/10 minutes

With Temperature Changes:

- Stabilized < 10 kHz/°C
- Unstabilized < 200 kHz/°C
- Auto stabilizer may be disabled in narrow spans (< 100 kHz/Div) by depressing front panel pushbutton switch to "OFF" position.

VIDEO FILTER

Video Filter bandwidths typically ± 20% of nominal value.

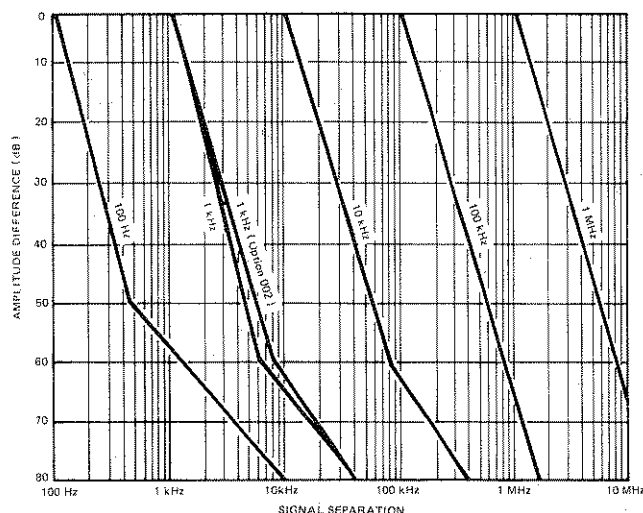

Figure 1. Typical Spectrum Analyzer Resolution

INTERNAL PRESELECTOR

Frequency Range	Description	Rejection
0.01 to 1.8 GHz	Low-pass filter	> 50 dB above 2.05 GHz
1.7 to 22 GHz	Tracking YIG tuned filter	> 70 dB greater than 642.8 MHz from center of pass band 1.7 to 18 GHz. > 60 dB from 18 to 22 GHz

TRACKING PRESELECTOR

Preselector skirt roll-off: Characteristics of a three-pole filter (nominally 18 dB/octave), 3 dB bandwidth typically varies from 25 MHz (at 1.7 GHz) to 70 MHz (at 22 GHz).

Table 1-2. HP Model 8569A Supplemental Characteristics (2 of 4)

SUPPLEMENTAL CHARACTERISTICS

NOTE: Values in this table are not specifications but are typical characteristics included for user information.

AMPLITUDE CHARACTERISTICS

DYNAMIC RANGE

Maximum power ratio of two signals simultaneously present at the input that may be measured within the limits of specified accuracy, sensitivity and distortion (i.e., spurious responses): 0.01 to 22 GHz > 70 dB.

Spurious responses: (Input attenuator set to 0 dB)

Second harmonic distortion

Frequency Range	Input Power	Relative Distortion
0.01 - 1.8 GHz	-35 dBm	< -70 dB
1.7 - 22 GHz	-10 dBm	< -100 dB*

*May be below average noise level

Third order intermodulation

Frequency Range	For Two Input Signals With		Relative Distortion
	Total Power	Signal Sep.	
0.01-22 GHz	-30 dBm	50 kHz	< -70 dB
1.7-12.9 GHz	-10 dBm	70 MHz	< -100 dB*
1.7-22 GHz	-10 dBm	100 MHz	< -100 dB*

*May be below average noise level

For typical harmonic and third order intermodulation distortion, see Figure 2.

Image and Multiple Responses:

Frequency	Image (out of band)	Multiple (in-band)
0.01-1.8 GHz	< -50 dB	non-existent
1.7-18 GHz	< -70 dB	< -70 dB
18-22 GHz	< -60 dB	< -60 dB

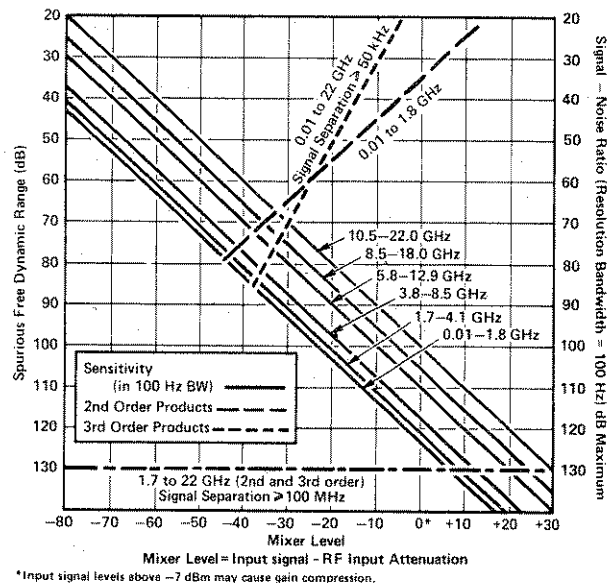

Figure 2. Optimum Dynamic Range Chart

AMPLITUDE ACCURACY

The overall amplitude accuracy of a measurement depends on an analyzer's performance and the measurement technique used. Applying IF substitution eliminates errors caused by the display, bandwidth gain variation, scale factor and input attenuator step size. Only IF gain variation (reference level change with input attenuation constant: $\pm 0.5\text{ dB}$), calibrator amplitude ($\pm 0.3\text{ dB}$), and frequency response remain. In brief, IF substitution minimizes error by minimizing control changes from the reference measurement (e.g., calibration).

For measurements in the Frequency Bands covering 1.7 to 22 GHz that don't require the best possible accuracy, the front panel preselector peak may be left centered in

Table 1-2. HP Model 8569A Supplemental Characteristics (3 of 4)

SUPPLEMENTAL CHARACTERISTICS

NOTE: Values in this table are not specifications but are typical characteristics included for user information.

its "green" setting. Best amplitude accuracy is obtained by peaking the preselector at the frequency of interest.

Reference Level Variation (For any change of scale factor): ± 1 dB.

FREQUENCY RESPONSE AND AVERAGE NOISE LEVEL

For typical frequency response and average noise level versus input frequency, see Figure 3.

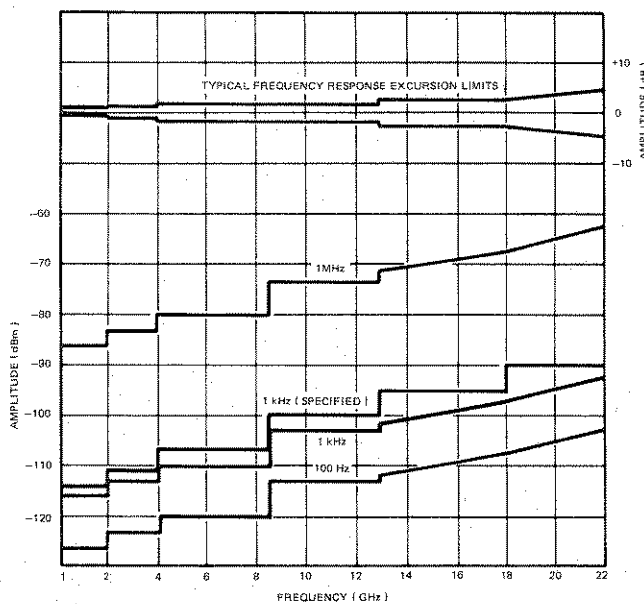

Figure 3. Typical Frequency Response and Average Noise Level Versus Input Frequency

SIGNAL INPUT CHARACTERISTICS

INPUT 50Ω 0.01 TO 22 GHz

Input connector: Precision type N female

Input impedance

Input attenuator at 0 dB: 50 ohms nominal

SWR: < 1.5 0.01 to 1.8 GHz
< 2.0 1.7 to 22 GHz (at analyzer tuned frequency)

Input attenuator at 10 dB or more: 50 ohms nominal

SWR: < 1.3 0.01 to 1.8 GHz
< 2.0 1.7 to 22 GHz

LO Emission (2.00 to 4.46 GHz):

< -60 dBm 0.01 to 1.8 GHz
< -80 dBm 1.7 to 22 GHz

Input Protection (For input signals from .01 to 22 GHz)
0.01 to 1.8 GHz Frequency Band: Internal diode limiter.
1.7 to 22 GHz Frequency Bands: Saturation of YIG filter (preselector) occurs at total input signal power levels below input mixer damage.

EXTERNAL MIXER INPUT

SMA female connector is a port for LO power transfer, bias current and IF return.

SWEEP CHARACTERISTICS

SWEEP SOURCE

Manual: Sweep determined by front panel control: continuously settable across CRT in either direction.

External: Sweep determined by 0 to +10V external signal applied to External Sweep input on rear panel. Blanking is controlled by signal at Blanking Input. Operation in Digital Storage Display mode with External sweep requires a Retrace signal input to rear panel Retrace Input connector.

Internal: Sweep generated from internal sweep generator.

SWEEP TRIGGER

Free Run: Sweep triggered repetitively by internal source.

Line: Sweep triggered by power line frequency.

Video: Sweep internally triggered by detected waveform of input signal (signal amplitude of 0.5 division peak-to-peak required on CRT display).

Trigger Level: Sets the level of the sweep trigger signal, whether it is the displayed trace (Video mode) or an external trigger input (Ext mode).

External Trigger: Sweep triggering determined by signal input (between +1 and +10 volts) to rear panel BNC connector.

Single: Sweep triggered or reset by front panel Start/Reset pushbutton.

Start/Reset: Triggers sweep in Single sweep mode. Can also reset any internal sweep to left edge of display.

Table 1-2. HP Model 8569A Supplemental Characteristics (4 of 4)

SUPPLEMENTAL CHARACTERISTICS

NOTE: Values in this table are not specifications but are typical characteristics included for user information.

REAR PANEL INPUT AND OUTPUT CHARACTERISTICS

Plotter Interface

Log: <0.1 dB/dB, max error <1 dB

Linear: <0.1 division

X, Y, and Z Axis Outputs: These outputs are compatible with and may be used to drive all current HP XY recorders (using positive pencoils or TTL penlift input) and CRT monitors.

Horizontal Sweep Output (X axis): A voltage proportional to the horizontal sweep of the CRT trace which ranges from -5V for the left graticule edge to +5V for the right graticule edge. Output impedance is 5 kohms.

Vertical Output (Y axis): Detected video output proportional to vertical deflection of the CRT trace. Output increases 100 mV/div from 0 to 800 mV (from a 50 ohm source) for a full 8-division deflection. Output impedance is 50 ohms.

Blank (Penlift or Z axis) Output: A blanking output, 15V from 10 kohms, which occurs during CRT retrace or when sweeping beyond band edges. Otherwise output is low at 0V with a 10 ohm output impedance for a normal or unblanked trace (pen down).

Blanking Input: Permits remote Z axis control of CRT with TTL levels; normal <0.5V or open circuit, blank >2V. Input impedance is 10 kohms. Note that in Digital Storage mode, Blanking input does not directly blank the CRT; instead it sets blank bits in the trace memory so that the appropriate parts of the trace are blanked during the CRT refresh cycle.

Caution: maximum input is $\pm 40V$.

External Sweep Input: When the front panel Sweep Source switch is set to the EXT mode, a 0 to 10V ramp will sweep the analyzer through the frequency range determined by front panel Tuning and Frequency Span/Div controls. Input impedance is 10 kohms.

Caution: maximum input $\pm 40V$.

Retrace Input: Required for operation in Digital Storage Display mode if External Sweep is used. Normal level

<0.5V, blank (retrace) level >2V. Input impedance is 10 kohms.

Caution: maximum input is $\pm 40V$.

External Trigger Input: With the Sweep Trigger in EXT mode, a signal will trigger a sweep on the signal's positive slope between +1 and +10 volts according to the setting of the Trigger Level control. 100 kohms input impedance, dc coupled.

Caution: maximum input $\pm 40V$.

21.4 MHz IF Output: A 50 ohm, 21.4 MHz output linearly related to the RF input to the analyzer. Bandwidth controlled by the analyzer's Resolution Bandwidth setting; amplitude controlled by the Input Attenuator, IF gain vernier and first 6 IF Reference Level step gain positions (-10 through -60 dBm level with 0 dB input attenuation). Output is approximately -10 dBm from 50 ohms for full scale signals on the CRT.

First LO Output: Connector is SMA Female, 50 ohms. Terminate in a 50 ohm load when not in use.

Frequency: 2.00 to 4.46 GHz

Power Level: typically at +8 dBm

Stability (Typical residual FM):

Stabilized: 30 Hz p-p

Unstabilized: 2 kHz p-p

Aux B: Used during factory calibration.

CATHODE RAY TUBE

Type: Post deflection accelerator, approximately 11.5 kV accelerating potential, aluminized P31 phosphor, electrostatic focus and deflection.

Graticule: Internal 8 \times 10 division. 1 division vertically is 1 centimeter, 1 division horizontally is 1.2 centimeters. There are 5 subdivisions per each major division.

Annotation: Major control settings are annotated on CRT.

Viewing Area: Approximately 9.6 centimeters vertically by 11 centimeters horizontally (3.8 inches by 4.7 inches).

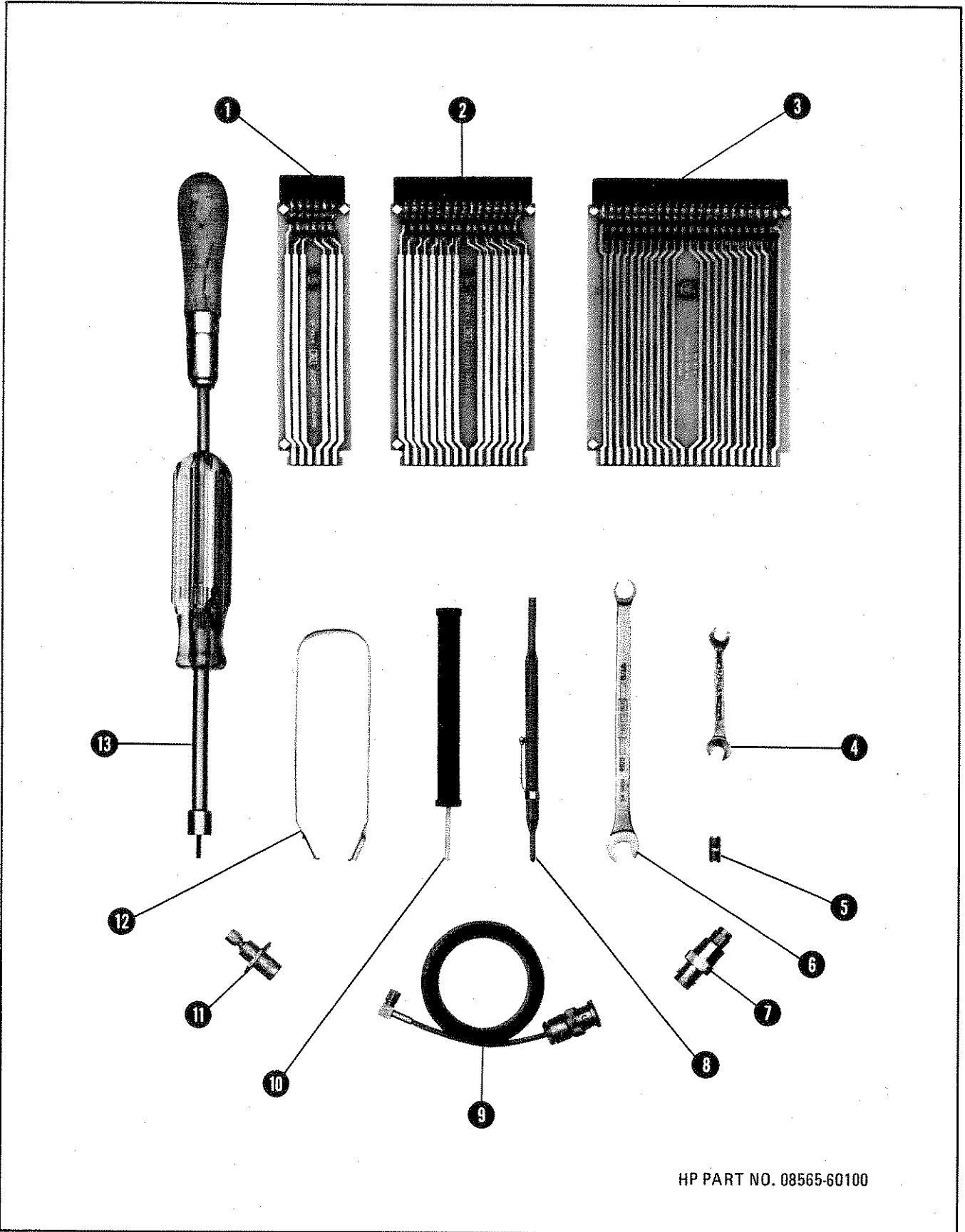

HP PART NO. 08565-60100

Figure 1-3. Service Accessories Package (1 of 2)

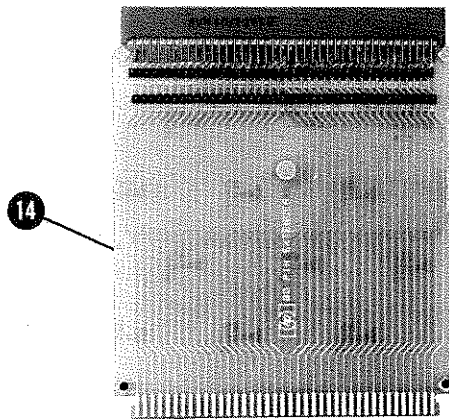

Item	Description	C D	HP Part Number
1	Extender board, 6 pin (12 conductors)	8	08505-60109
2	Extender board, 15 pin (30 conductors)	7	08505-60041
3	Extender board, 22 pin (44 conductors)	8	08565-60107
4	Wrench, 15/64 inch open end	8	8710-0946
5	Adapter, SMA male to male	3	1250-1158
6	Wrench, 5/16 inch slotted box end/open end	9	08555-20097
7	Adapter, BNC female to SMA male	6	1250-1200
8	Alignment tool	7	8710-0630
9	Test cable, subminiature (SMC) female to BNC male (36 inches long)	1	11592-60001
10	Alignment tool, non-metallic	4	8710-0033
11	Adapter, BNC female to SMC female (used to measure second LO output)	3	08565-60087
12	Connector extractor	6	8710-0580
13	Tuning tool (consists of modified 5/16 inch nut driver with modified No. 10 Allen driver)	6	08555-60107
14	Extender board, 40 pin (80 conductors)	9	08569-60013

Figure 1-3. Service Accessories Package (2 of 2)

Table 1-3. Recommended Test Equipment (1 of 3)

Instrument	Critical Specifications	Recommended Model	Use*
Digital Voltmeter	Range: -1000V to +1000V Accuracy: $\pm 0.004\%$ of reading plus 0.001% of range Input Impedance: 10 Meg ohms	HP 3455A	P,A,T
Oscilloscope	Frequency: 100 MHz	HP 1741A	A, T
Probe	10:1 Divider	HP 10004D	A, T
Probe	1:1 Divider	HP 10007D	A, T
Probe	High Voltage, 4 kV	HP 34111A	A, T
Function Generator	Amplitude: 0 to +10V p-p sine wave with dc offset Frequency: 1 to 5 kHz	HP 3312A	P,A,T
Pulse Generator	Transition Time: < 10 ns Pulse Width: 1 μ s to 1 ms Pulse Repetition Rate: 10 kHz to 1 MHz Pulse Amplitude: 0V to +10V	HP 8013B	A
Comb Generator	Frequency Markers: 10 and 100 MHz Increments up to 5 GHz	HP 8406A	P, A
Signal Generator	Frequency: 50 to 500 MHz Modulation Frequency: 100 kHz Modulation Deviation: 1% of lowest frequency in range	HP 8640B, Opt. 001	P,A,T
Synthesized Signal Generator	Frequency Resolution: 2 Hz	HP 8660A/C	P
Frequency Counter	Range: .01 to 24.5 GHz	HP 5342A, Opt. 005	P,A,T
Electronic Counter	Time Interval Counter Function	HP 5300A/5302A	A
Power Meter	Range: -20 to +10 dBm	HP 435B	P,A,T
Power Sensor	Frequency Range: .05 to 26.5 GHz	HP 8485A	P,A,T
Power Sensor	Frequency Range: .01 to 18 GHz	HP 8481A, Opt. C03	P,A,T
Spectrum Analyzer	Frequency: 300 MHz	HP 140T/8552B/ 8554B	A, T
Tracking Generator	Frequency: 300 MHz	HP 8444A, Opt. 059	A, T
Sweep Oscillator	Mainframe for RF Plug-In	HP 8350A	P,A,T

Table 1-3. Recommended Test Equipment (2 of 3)

Instrument	Critical Specifications	Recommended Model	Use*
Sweep Oscillator	Mainframe for RF Plug-In (Alternate for HP 8350A)	HP 8620C	P,A,T
RF Plug-In	Frequency: .01 to 2.4 GHz	HP 86222A	P, A
RF Plug-In	Frequency: 2 to 22 GHz Residual FM: < 30 kHz in 10 kHz Bandwidth	HP 86290A, Opt. H08	P,A,T
Synchronizer	No Substitute	HP 8709A, Opt. H10	A
DC Power Supply	4 to 6 volts dc (Floating)	HP 6214A	A
Termination	Frequency: dc to 18 GHz Impedance: 50 Ohms Connector: Type N Male	HP 909A, Opt. 012	P
Mixer	Input Frequency: 23 GHz	HP 11517A, Opt. E03	P
Power Splitter	Frequency: 2 to 18 GHz Attenuation: 6 dB each arm Connectors: Type N Female Input APC-7 Outputs	HP 11667A, Opt. 002	P, A
Crystal Detector	Frequency: .1 to 22 GHz Input Connector: APC-3.5	HP 33330C	P,A,T
Attenuator	Attenuation: 10 dB \pm 0.5 dB Frequency: .01 to 18 GHz Connectors: Type N	HP 8491B, Opt. 010	P, A
Attenuator	Attenuation: 10 dB \pm 0.5 dB Frequency: .01 to 18 GHz Connectors: APC-7	HP 8492A, Opt. 010	P
Step Attenuator	Attenuation: 0 to 12 dB in 1 dB steps Frequency: 100 MHz, Calibrated	HP 355C, Opt. H80	P, A
Step Attenuator	Attenuation: 0 to 120 dB in 10 dB steps Frequency: 100 MHz, Calibrated	HP 355D, Opt. H80	P, A
Adapter (2 required)***	Waveguide to SMA Jack	Narda 4608	P, A
Adapter	Type N Female to BNC Male	HP 1250-0077	P
Adapter (2 required)	Type N Male to BNC Female	HP 1250-0780	P, T
Adapter	Type N Plug to SMA Jack	HP 1250-1250	P, T

Table 1-3. Recommended Test Equipment (3 of 3)

Instrument	Critical Specifications	Recommended Model	Use*
Adapter**	BNC Female to SMC Female	HP 08565-60087	A, T
Adapter	K-Band to R-Band; for use with HP 11517A Mixer	HP 11519A	P
Adapter	APC-7 to Type N Female	HP 11524A	P, A
Adapter	APC-7 to Type N Male	HP 11525A	P, A
Adapter	APC-7 to SMA Female	HP 11534A	P, A
Adapter	Type N Female to SMA Female	HP 86290-60005	P, T
Adapter	Type N Male to SMA Female	HP 1250-1404	P, T
Cable Assembly	SMA Plug both ends	HP 8120-1578	P, T
Cable Assembly	Type N Connector both ends	HP 11500A	P, T
BNC Short	Impedance: 50 Ohms	HP 1250-0774	A
BNC Tee	Connectors: BNC Jack and Plug	HP 1250-0781	A
Test Cable**	SMA Female to BNC Male	HP 11592-60001	P

* P = Performance Test; A = Adjustment; T = Troubleshooting
** These parts are included in Service Accessories Package; HP Part Number 08565-60100
*** Only one required if HP 86290A, Opt. H08 used

SECTION II

INSTALLATION AND OPERATION VERIFICATION

2-1. INTRODUCTION

2-2. This section includes information about the initial inspection, preparation for use, storage and shipment, and operation verification for the HP Model 8569A.

2-3. INITIAL INSPECTION

2-4. Inspect the shipping container for damage. If the shipping container or cushioning material is damaged, it should be kept until the contents of the shipment have been checked for completeness and the instrument has been checked mechanically and electrically. The contents of the shipment should be as shown in Figure 1-1. The electrical performance is checked by the operation verification procedure in this section. If the contents are incomplete, if there is mechanical damage or defect, or if the instrument does not pass the operation verification test, notify the nearest Hewlett-Packard office. If the shipping container is damaged, or if the cushioning material shows signs of stress, notify the carrier as well as the Hewlett-Packard office. Keep the shipping materials for inspection by the carrier. The HP office will arrange for repair or replacement without waiting for a claim settlement.

2-5. PREPARATION FOR USE

2-6. Power Requirements

2-7. The HP Model 8569A requires a power source of 100, 120, 220, or 240 Vac $\pm 5\%$ -10% , 48-66 Hz. Power consumption is less than 220 volt-amperes. The Option 400 permits operation on line frequencies of 50, 60, and 400 Hz at the voltages specified above.

2-8. Line Voltage and Fuse Selection

WARNING

BEFORE THIS INSTRUMENT IS TURNED ON, its protective earth terminals must be connected to the protective conductor of the main power cable. The main power cable

plug shall be inserted only in a socket outlet that is provided with a protective earth contact. DO NOT negate the earth-grounding protection by using an extension cable, a power cable, or an autotransformer without a protective ground conductor. Failure to ground the instrument properly can result in personal injury.

CAUTION

BEFORE TURNING ON THIS INSTRUMENT, make sure it is adapted to the voltage of the ac power source. The voltage selector card must be correctly set to adapt the HP Model 8569A to the power source. Failure to set the ac power input of the instrument for the correct voltage level could cause damage to the instrument when it is turned on.



2-9. Select the line voltage and fuse as follows:

1. Measure the ac line voltage.
2. See Figure 2-1. At the power line module (rear panel), select the line voltage (100V, 120V, 220V, or 240V) closest to the voltage measured in step 1. Line voltage must be within $+5\%$ or -10% of the voltage setting. If it is not, use an autotransformer between the ac source and the instrument.
3. Make sure the correct fuse is installed in the fuse holder. The required fuse rating for each line voltage is indicated below the power line module.

2-10. Cable Connections

2-11. Power Cable. In accordance with international safety standards, this instrument is equipped with a three-wire power cable. When connected to the appropriate power line outlet, this cable grounds the instrument cabinet. Table 2-1 shows the styles of plugs available on power cables supplied with HP instruments.

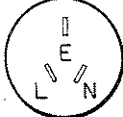
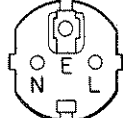
Table 2-1. AC Power Cables Available

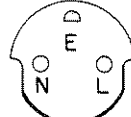
Plug Type	HP Part Number	C D	Plug Description	Length cm (inches)	Color	Country of Use
<p>250V</p> 	8120-1351 8120-1703	0 6	Straight *BS1363A 90°	229 (90) 229 (90)	Mint Gray Mint Gray	United Kingdom, Cyprus, Nigeria, Rhodesia, Singapore, South Africa, India
<p>250V</p> 	8120-3169 8120-0696	0 4	Straight *NZSS198/ASC112 90°	201 (79) 221 (87)	Gray Gray	Australia, New Zealand
<p>250V</p> 	8120-1689 8120-1692	7 2	Straight *CEE7-Y11 90°	201 (79) 201 (79)	Mint Gray Mint Gray	East and West Europe, Saudi Arabia, Egypt, South Africa, India (unpol- arized in many nations)
<p>125V</p> 	8120-1348 8120-1398 8120-1754 8120-1378 8120-1521 8120-1676	5 5 7 1 6 2	Straight *NEMA5-15P 90° Straight *NEMA5-15P Straight *NEMA5-15P 90° Straight *NEMA5-15P	203 (80) 203 (80) 91 (36) 203 (80) 203 (80) 91 (36)	Black Black Black Jade Gray Jade Gray Jade Gray	United States, Canada, Japan (100V or 200V), Mexico, Philip- pines, Taiwan
<p>250V</p> 	8120-2104	3	Straight *SEV1011 1959-24507 Type 12	201 (79)	Gray	Switzerland
<p>220V</p> 	8120-1957 8120-2956	2 3	Straight *DHCK 107 90°	201 (79) 201 (79)	Gray Gray	Denmark
<p>*Part number shown for plug is industry identifier for plug only. Number shown for cable is HP Part Number for complete cable including plug. E = Earth Ground; L = Line; N = Neutral</p>						

WARNING

If this instrument is to be energized through an autotransformer, make sure the common terminal of the autotransformer is connected to the protective earth contact of the power source outlet socket.

Any interruption of the protective ground, inside or outside the instrument, can make it a shock hazard.

2-12. Mating Connectors

2-13. All mating connectors on the Model HP 8569A Spectrum Analyzer have standard Hewlett-Packard part numbers and are readily available.

2-14. Operating Environment

2-15. **Temperature.** The instrument may be operated in temperatures from 0°C to +55°C.

2-16. **Humidity.** The instrument may be operated in environments with humidity from 5% to 95% at 0°C to 40°C. However, the instrument should also be protected from temperature extremes that cause internal condensation.

2-17. **Altitude.** The instrument may be operated at altitudes up to 4572 meters (15,000 feet).

2-18. Bench Operation

2-19. The cabinet of the instrument has plastic feet and foldaway tilt stands for convenience in bench operation. The tilt stands raise the front of the instrument for easier viewing of the control panel. The plastic feet are shaped to make full width modular instruments self-aligning when stacked.

2-20. Rack Mounting (Options 908 and 913)

2-21. Instruments with Option 908 are shipped with a Rack Flange Kit, which supplies necessary hardware, with installation instructions, for mounting the instrument on a rack whose spacing is 482.6 mm (19 inches). Installation instructions are also given in Figure 2-2. See Table 2-2 for HP part numbers.

2-22. Instruments with Option 913 are shipped with a Rack Flange/Front Handle Kit, which supplies necessary hardware, with installation instructions, for the addition of front handles and mounting the instrument on a rack whose spacing is 482.6 mm (19 inches). Installation instructions are also given in Figure 2-2. See Table 2-2 for HP part numbers.

2-23. Front Handles

2-24. Instruments are shipped with a Front Handle Kit, which supplies necessary hardware, with installation instructions, for mounting front handles on the instrument. See Figure 2-2 for installation instructions.

Table 2-2. Rack-Mounting Kits for HP 8569A

Description	C D	HP Part Number	Quantity
OPTION 908			
Rack Flange	8	5020-8863	2
Machine Screw, Pan Head, 8-32 x 0.375 inch	7	2510-0193	8
OPTION 913			
Handle Assembly	0	5060-9900	2
Rack Flange	2	5020-8875	2
Machine Screw, Pan Head, 8-32 x 0.625 inch	8	2510-0194	8

RECEPTACLE FOR PRIMARY POWER CORD

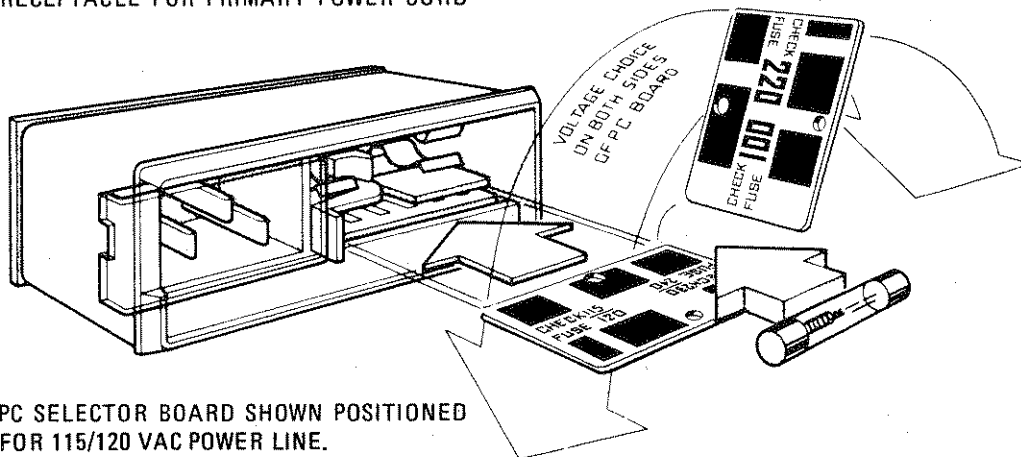

PC SELECTOR BOARD SHOWN POSITIONED FOR 115/120 VAC POWER LINE.

OPERATING VOLTAGE APPEARS IN MODULE WINDOW.

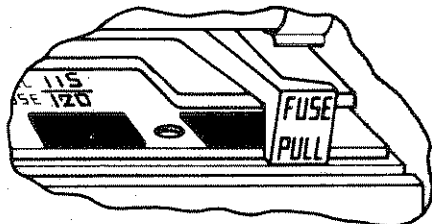

SELECTION OF OPERATING VOLTAGE

1. SLIDE OPEN POWER MODULE COVER DOOR AND PUSH FUSE-PULL LEVER TO LEFT TO REMOVE FUSE.
2. PULL OUT VOLTAGE-SELECTOR PC BOARD. POSITION PC BOARD SO THAT VOLTAGE NEAREST ACTUAL LINE VOLTAGE LEVEL WILL APPEAR IN MODULE WINDOW. PUSH BOARD BACK INTO ITS SLOT.
3. PUSH FUSE-PULL LEVER INTO ITS NORMAL RIGHT-HAND POSITION.
4. CHECK FUSE TO MAKE SURE IT IS OF CORRECT RATING AND TYPE FOR INPUT AC LINE VOLTAGE. FUSE RATINGS FOR DIFFERENT LINE VOLTAGES ARE INDICATED BELOW POWER MODULE.
5. INSERT CORRECT FUSE IN FUSEHOLDER.

Figure 2-1. Line Voltage Selection with Power Module PC Board

**OPTION 908
RACK MOUNTING KIT
WITHOUT FRONT
HANDLES
(HP 5061-0078)**

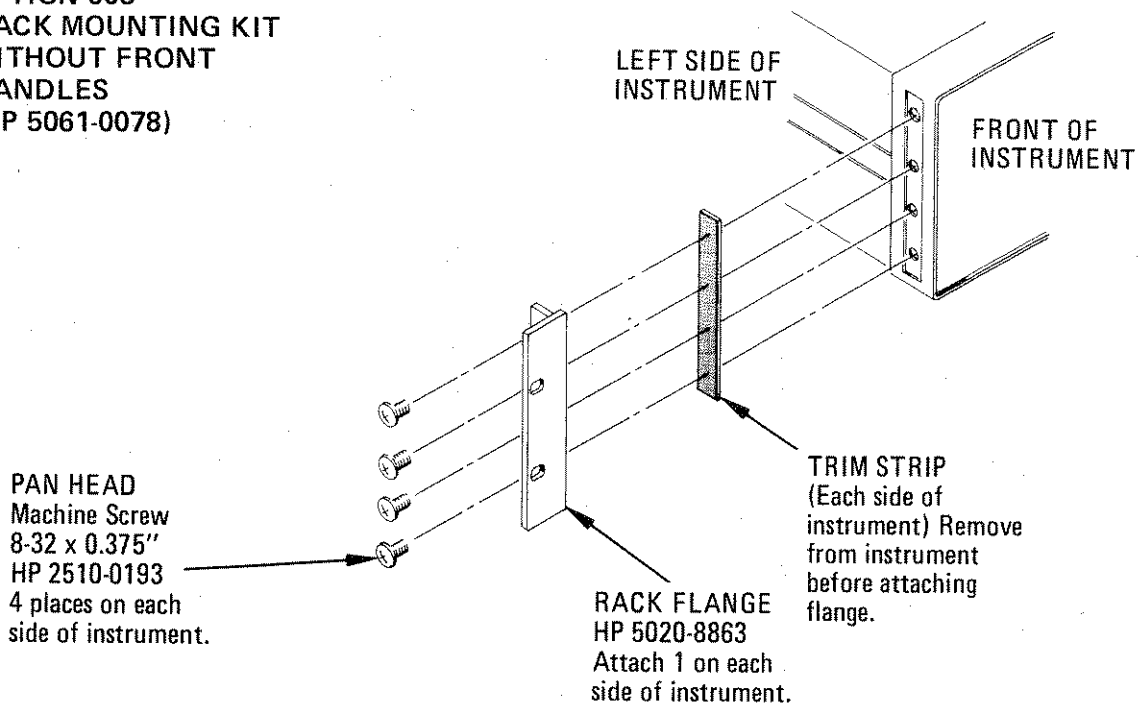

**OPTION 913
RACK MOUNTING KIT
WITH FRONT
HANDLES
(HP 5061-0084)**

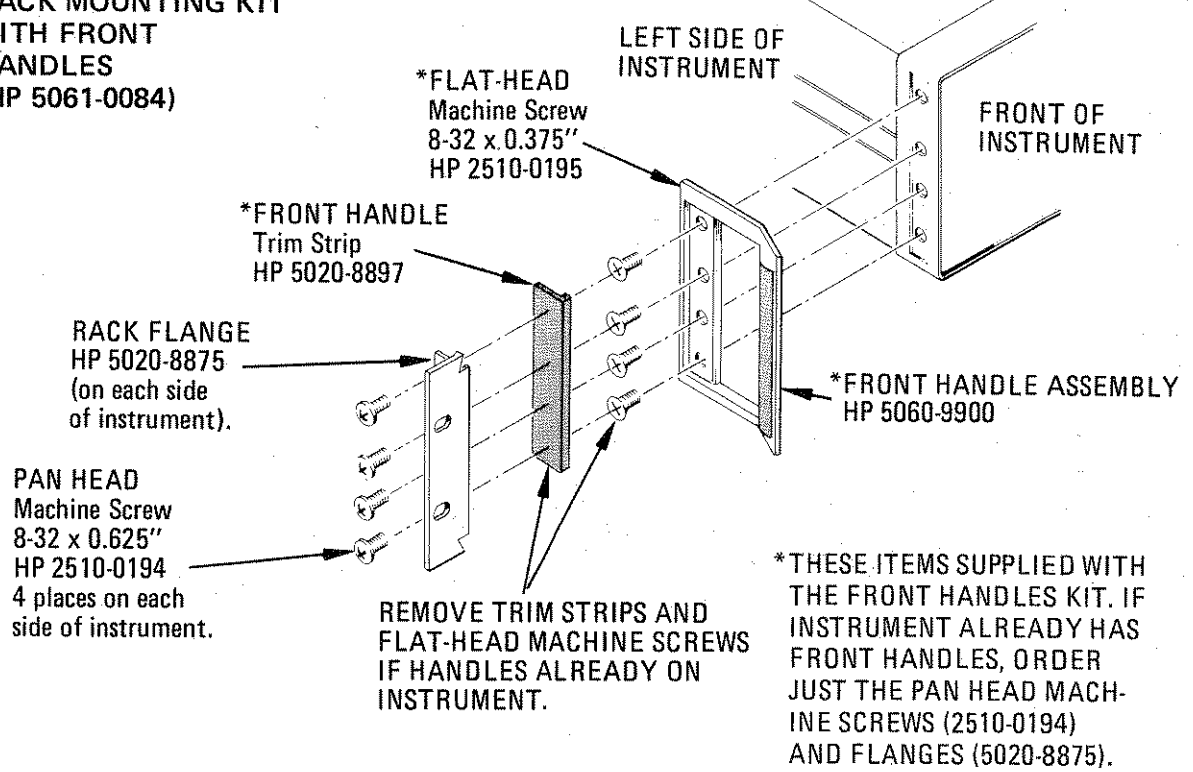
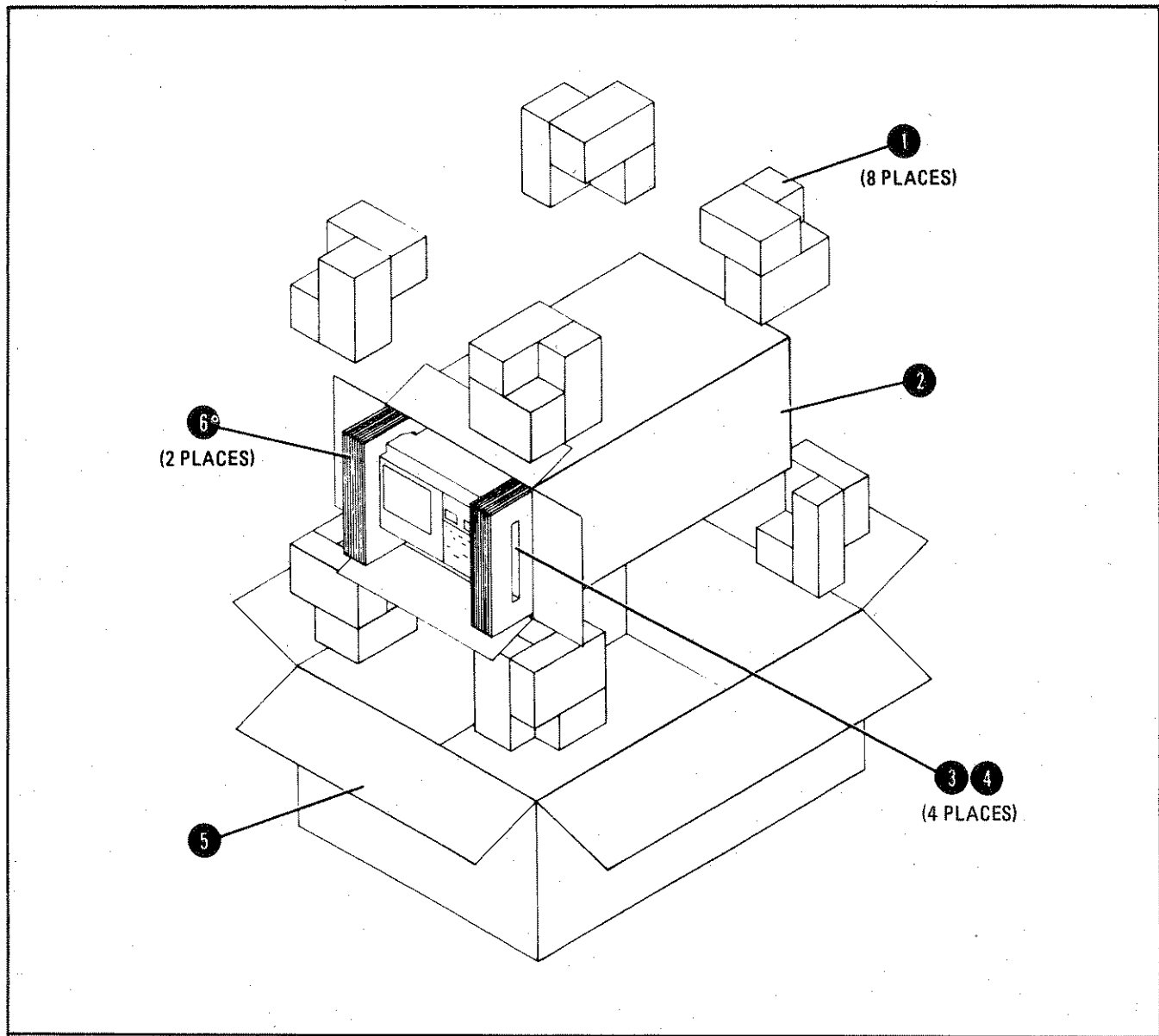

Figure 2-2. Attaching Rack Mounting Hardware and Handles



Item	Qty	C D	HP Part No.	Description
1	8	7	9220-2733	FOAM PADS—TOP CORNER; BOTTOM CORNER
2	1	4	9211-2622	CARTON—INNER
3	4	3	4040-1738	BARS—SHIPPING, PLASTIC
4	8	9	2510-0103	SCREW—FOR ATTACHING SHIPPING BARS (REMOVE HANDLES FOR SHIPMENT)
5	1	5	9211-2623	CARTON—OUTER
6	2	9	9220-2735	SIDE PADS, CORRUGATED CARDBOARD
7	1	2	9222-0069	BAG, PLASTIC

Figure 2-3. Packaging for Shipment Using Factory Packaging Materials

2-25. STORAGE AND SHIPMENT**2-26. Environment**

2-27. The instrument may be stored or shipped in environments within the following limits:

Temperature -40°C to $+75^{\circ}\text{C}$
 Humidity 5% to 95% at 0°C to 40°C
 Altitude Up to 15,240 meters (50,000 feet)

The instrument should also be protected from temperature extremes that cause internal condensation.

2-28. Packaging

2-29. Original Packaging. Containers and materials identical to those used in factory packaging are available through Hewlett-Packard offices. Figure 2-3 illustrates the proper method of packaging the instrument for shipment using factory packaging materials. If the instrument is being returned to Hewlett-Packard for servicing, attach a tag indicating the type of service required, return address, model number, and full serial number. A supply of these tags is provided at the end of this section. Also mark the container **FRAGILE** to assure careful handling. In any correspondence, refer to the instrument by model number and full serial number.

2-30. Other Packaging. The following general instructions should be used for repackaging with commercially available materials:

1. Wrap the instrument in heavy paper or plastic. If shipping to a Hewlett-Packard office or service center, attach a tag indicating the type of service required, return

address, model number, and full serial number. A supply of these tags is provided at the end of this section.

2. Use a strong shipping container. A double-wall carton made of 350-pound test material is adequate.
3. Use enough shock-absorbing material (3-inch to 4-inch layer) around all sides of the instrument to provide firm cushion and prevent movement inside the container. Protect the control panel with cardboard.
4. Seal the shipping container securely.
5. Mark the shipping container **FRAGILE** to assure careful handling.

2-31. OPERATION VERIFICATION

2-32. The Operation Verification is designed to test only the most critical specifications and operating features of the instrument. It requires much less time and equipment than the complete performance tests listed in Section IV and is recommended for verification of overall instrument operation, either as part of incoming inspection or after repair. The Operation Verification consists of the following tests:

- Operational Check
- Tuning Accuracy
- Frequency Span Width and Resolution Bandwidth Accuracy
- Amplitude Accuracy

OPERATION VERIFICATION

NOTE

Allow at least 30 minutes warmup time.

EQUIPMENT:

Frequency Counter	HP 5340A
Comb Generator	HP 8406A
Power Meter	HP 435A
Power Sensor	HP 8481A
Step Attenuator (10 dB/Step)	HP 355D

NOTE

If substitution is necessary for any of the above listed equipment, the alternate models must meet or exceed the critical specifications listed in Table 1-3.

2-33. OPERATIONAL CHECK
PROCEDURE:

1. Perform front panel adjustment procedure provided on pull-out card.
2. Connect comb generator (100 MHz comb) to HP 8569A INPUT 50 Ω connector. Set all normal (green) settings, except set TRACE A and TRACE B to STORE BLANK. Set FREQUENCY SPAN/DIV to 1 MHz and TUNING to 0.100 GHz. Verify indication noted in Table 2-4 for each setting shown.

NOTE

In checking some functions, first press CLEAR/RESET to clear digital trace from CRT display.

OPERATION VERIFICATION

Table 2-3. Operational Check (1 of 3)

Function	Setting	Indication
SWEEP SOURCE	MAN	Rotation of MANUAL SWEEP control varies position of trace on CRT display.
	EXT	No sweep. Bright dot on lower left edge of CRT display.
	INT	Sweep visible on CRT display.
SWEEP TRIGGER	LINE	Sweep visible on CRT display.
	VIDEO	Presence of CRT sweep is dependent on TRIGGER LEVEL setting.
	EXT	No CRT trace is visible.
	SINGLE	One sweep is triggered when START/RESET push-button is pressed.
	FREE RUN	Sweep visible on CRT display.
SWEEP TIME/DIV	Slowly rotate control counterclockwise.	Sweep on CRT display becomes increasingly slower.
	<p>NOTE</p> <p>Select 1.7–4.1 FREQUENCY BAND GHz and adjust TUNING control to center signal on CRT display.</p>	
PRESELECTOR PEAK	Rotate over full range.	Signal amplitude varies. (Set control for maximum signal amplitude.)
	<p>NOTE</p> <p>Set FREQUENCY SPAN/DIV to 100 kHz and adjust FINE tuning control to center signal on CRT display.</p>	
AUTO STABILIZER (Blue FREQUENCY SPAN/DIV settings)	OFF (in)	Tuning of signal with coarse TUNING control is continuous.
	ON (out)	Tuning of signal with coarse TUNING control causes signal to jump off CRT display.

OPERATION VERIFICATION

Table 2-3. Operational Check (2 of 3)

Function	Setting	Indication
FREQUENCY SPAN MODE	<p align="center">NOTE</p> <p align="center">Set TRACE A to WRITE and FREQUENCY SPAN/DIV to 100 MHz.</p>	
	PER DIV	Signals are displayed at one-division intervals.
	<p align="center">NOTE</p> <p align="center">Set FREQUENCY SPAN/DIV to .2 MHz and adjust TUNING control to center signal on CRT display.</p>	
	ZERO SPAN	CRT trace is a straight line and FINE TUNING control affects signal amplitude.
	FULL BAND	Twenty-five comb teeth are visible and baseline marker position is determined by coarse TUNING control.
1.7–22 GHz SPAN	Baseline is displayed from left to right in five steps (see Section III). Return to PER DIV.	
AMPLITUDE SCALE (Center signal on CRT display.)	10 dB (LOG/DIV)	10 dB change in REF LEVEL dBm changes signal amplitude by one division ± 0.1 division.
	<p align="center">NOTE</p> <p align="center">Set REF LEVEL dBm and REFERENCE LEVEL FINE to position signal peak 0.5 division below REFERENCE LEVEL graticule line. Center signal on CRT display with TUNING control.</p>	
	5 dB (LOG/DIV)	Signal peak one division below REFERENCE LEVEL graticule line (± 0.25 division).
	2 dB (LOG/DIV)	Signal peak 2.5 divisions below REFERENCE LEVEL graticule line (± 0.6 division).
	1 dB (LOG/DIV)	Signal peak 5 divisions below REFERENCE LEVEL graticule line (± 1.2 divisions).
LIN	Signal peak 3.5 divisions below REFERENCE LEVEL graticule line (± 1.0 division). Return to 10 dB.	

OPERATION VERIFICATION

Table 2-3. Operational Check (3 of 3)

Function	Setting	Indication
TRACE A	MAX HOLD	Increase and then decrease signal amplitude. Maximum signal is held on CRT display.
	STORE VIEW	Trace is held on CRT display and is not affected by changes in control settings.
	STORE BLANK	Analog signal is displayed without CRT annotation.
TRACE B	Set TRACE B to WRITE and repeat checks described for TRACE A.	
TRACES A and B STORE VIEW	Set TRACE A to WRITE, then to STORE BLANK. With TRACE B set to WRITE, vary signal amplitude or position, then set TRACE B to STORE VIEW. Set TRACE A to STORE VIEW. Both traces are displayed on CRT.	
<p>NOTE</p> <p>Set TRACE A to WRITE and TRACE B to STORE BLANK. Set FREQUENCY SPAN/DIV to 1 MHz and RESOLUTION BW to 30 kHz. Center signal on CRT display with TUNING control.</p>		
SIG IDENT	Depressed	Two signals on CRT display. Signal identifier signal is two divisions to left of comb tooth and is also lower in amplitude.
CRT Annotation	TRACE A to WRITE	Control settings are displayed on CRT, and annotation changes as settings are changed.
VIDEO FILTER	Step through each switch position	Each step decreases baseline noise level and decreases sweep speed. Sweep speed increases when switching to NOISE AVG position, and CRT trace is virtually a straight line.

2-34. TUNING ACCURACY

SPECIFICATION:

Overall tuning accuracy of the digital frequency readout in any span mode:

Internal Mixing:

± (5 MHz or 0.2% of center frequency, whichever is greater, plus 20% of frequency span per division)

OPERATION VERIFICATION

2-34. Tuning Accuracy (Cont'd)

DESCRIPTION:

The tuning accuracy of the HP 8569A is verified by means of a comb generator at the first two FREQUENCY BAND GHz settings. The CAL OUTPUT frequency is measured, and the HP 8569A is calibrated at 100 MHz. The comb generator is then connected to the INPUT 50Ω connector of the HP 8569A, and the tuning accuracy is checked.

PROCEDURE:

1. Connect frequency counter to spectrum analyzer CAL OUTPUT as shown in Figure 2-4. Set all normal (green) settings, and other controls as follows:

TRACE A	WRITE
TRACE B	STORE BLANK
FREQUENCY BAND GHz01 - 1.8
TUNING	0.100 GHz
INPUT ATTEN	10 dB
REF LEVEL dBm	-10
REFERENCE LEVEL FINE	0
FREQUENCY SPAN/DIV	1 MHz
RESOLUTION BW	30 kHz

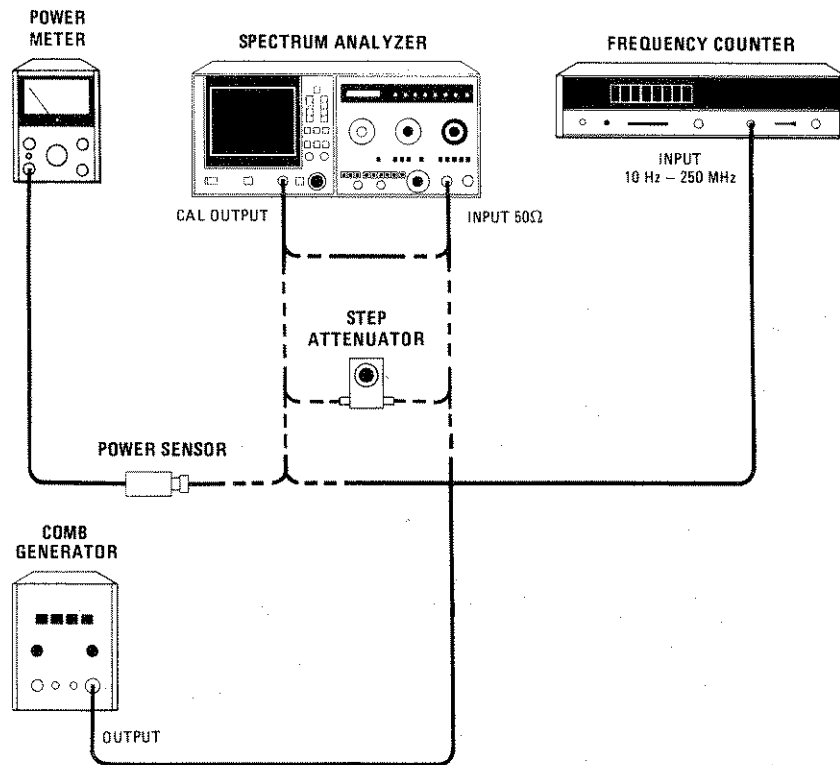

Figure 2-4. Operation Verification Test Setup

OPERATION VERIFICATION

2-34. Tuning Accuracy (Cont'd)

2. Measure spectrum analyzer CAL OUTPUT frequency using frequency counter. Reading should be $100 \text{ MHz} \pm 0.01 \text{ MHz}$.
 3. Calibration of FREQUENCY GHz display is initially adjusted at 100 MHz. Connect CAL OUTPUT to INPUT 50Ω and tune instrument to center signal on CRT display. FREQUENCY GHz readout should be 0.100. If necessary, adjust FREQ CAL screwdriver adjustment for 0.100 on FREQUENCY GHz display. Check that CTR annotation on CRT reads 100.0 MHz.
 4. Verify calibration of FREQUENCY GHz display in other frequency bands as follows:
 - a. Tune instrument for an indication of 1.800 GHz on FREQUENCY GHz digital readout.
 - b. Connect comb generator to spectrum analyzer INPUT 50Ω and tune instrument to center 1.8 GHz comb tooth on CRT display. FREQUENCY GHz readout must be $1.800 \pm 0.005 \text{ GHz}$.
 - c. Select 1.7–4.1 FREQUENCY BAND GHz and set TUNING control for an indication of 3.000 GHz on FREQUENCY GHz readout.
 - d. Center 3.0 GHz comb tooth on CRT display. FREQUENCY GHz readout must be $3.000 \pm 0.006 \text{ GHz}$.
 - e. Set TUNING control for an indication of 4.000 GHz on FREQUENCY GHz readout.
 - f. Center 4.0 GHz comb tooth on CRT display. FREQUENCY GHz readout must be $4.000 \pm 0.008 \text{ GHz}$.
-

2-35. FREQUENCY SPAN WIDTH AND RESOLUTION BANDWIDTH ACCURACY**SPECIFICATION:**

Span width accuracy: The frequency error for any two points on the display for spans from 500 MHz to 20 kHz/Div (unstabilized) is less than $\pm 5\%$ of the indicated separation; for stabilized spans 100 kHz/Div and less, the error is less than $\pm 15\%$.

Resolution bandwidth accuracy: Individual resolution bandwidth 3 dB points: $< \pm 15\%$.

DESCRIPTION:

A comb generator is used to check the span width and the CAL OUTPUT signal is used to check resolution bandwidth accuracy at different positions of the FREQUENCY SPAN/DIV and RESOLUTION BW controls. By verifying the calibration of these controls, proper operation of the sweep circuits is also verified.

OPERATION VERIFICATION

2-35. Frequency Span Width and Resolution Bandwidth Accuracy (Cont'd)

PROCEDURE:

1. Connect comb generator to instrument INPUT 50 Ω .
2. Set all normal (green) settings, and other controls as follows:

Spectrum Analyzer:

TRACE A	WRITE
TRACE B	STORE BLANK
FREQUENCY BAND GHz01 – 1.8
FREQUENCY SPAN/DIV	100 MHz
RESOLUTION BW	1 MHz (coupled)
INPUT ATTEN	10 dB
REF LEVEL dBm	0
TUNING	0.500 GHz

Comb Generator:

Comb frequency	100 MHz
Output amplitude	Optimum

3. Tune spectrum analyzer to position one comb tooth at graticule reference line (far left).
4. Note position of ninth spectral line (comb tooth). It must be on eighth graticule line ± 0.4 division. (See Figure 2-5.)
5. Set FREQUENCY SPAN/DIV to 10 MHz (with RESOLUTION BW coupled) and comb generator to 10 MHz. Repeat steps 3 and 4.
6. Set FREQUENCY SPAN/DIV to 1 MHz and comb generator to 1 MHz. Repeat steps 3 and 4.

NOTE

The wider FREQUENCY SPAN/DIV settings are checked using a comb generator. The narrow FREQUENCY SPAN/DIV settings are checked by observing RESOLUTION BW accuracy as follows:

7. Set FREQUENCY SPAN/DIV to .2 MHz, RESOLUTION BW to 1 MHz, and AMPLITUDE SCALE to 1 dB.
8. Connect spectrum analyzer CAL OUTPUT to INPUT 50 Ω and tune spectrum analyzer to 0.100 GHz. Center signal on display and use REFERENCE LEVEL controls to position peak of signal to REFERENCE LEVEL line.
9. Note width of signal three divisions below REFERENCE LEVEL line. Specification: 5 divisions ± 0.75 division. Verification of the 1 MHz RESOLUTION BW setting verifies proper operation of the LC bandwidth filters.

OPERATION VERIFICATION

2-35. Frequency Span Width and Resolution Bandwidth Accuracy (Cont'd)

10. Set FREQUENCY SPAN/DIV to 10 kHz and RESOLUTION BW to 30 kHz.
11. Repeat step 8 and note width of signal three divisions below REFERENCE LEVEL line. Specification: 3 divisions ± 0.45 division. Verification of the 30 kHz RESOLUTION BW setting verifies proper operation of the crystal bandwidth filters.

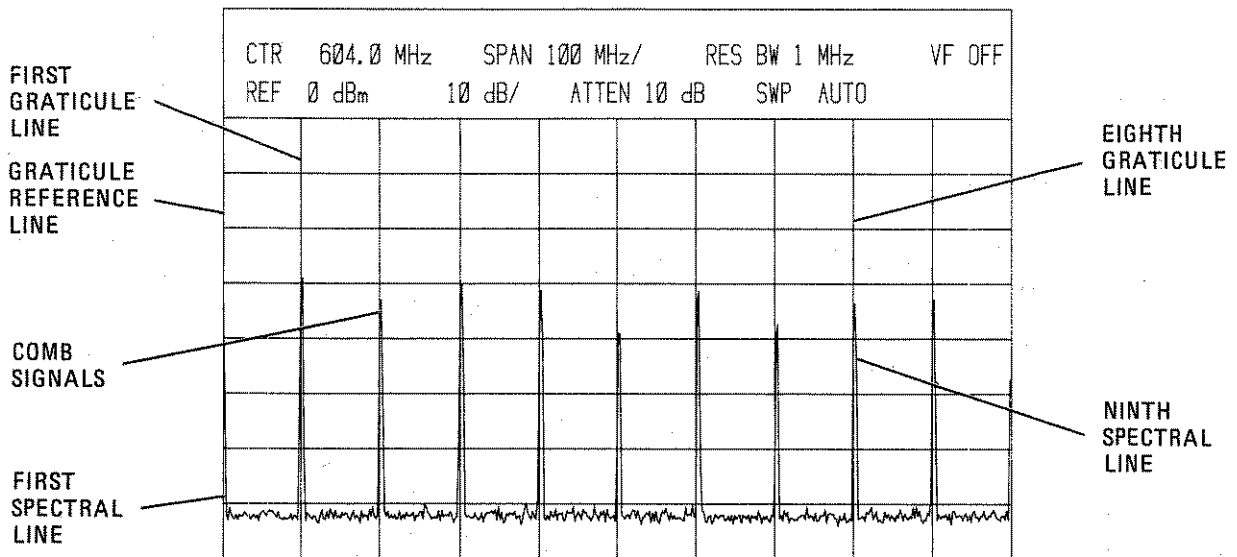

Figure 2-5. Span Width Accuracy Measurement

2-36. AMPLITUDE ACCURACY

SPECIFICATIONS:

Calibrator Output: $-10 \text{ dBm} \pm 0.3 \text{ dB}$

Reference Level variation (Input Attenuator at 0 dB):

10 dB steps, $+20^\circ\text{C}$ to $+30^\circ\text{C}$:

0 to -60 dBm : $< \pm 0.5 \text{ dB}$

0 to -90 dBm : $< \pm 1.0 \text{ dB}$

Vernier (0 to -12 dB) continuous:

Maximum error $< \pm 0.5 \text{ dB}$, when read from REFERENCE LEVEL FINE control.

Input Attenuator (at preselector input, 70 dB range in 10 dB steps):

Step size variation (for steps from 0 to 60 dB):

0 to 60 dB, 0.01-18 GHz: $< \pm 1.0 \text{ dB}$

0 to 40 dB, 0.01-22 GHz: $< \pm 1.5 \text{ dB}$

OPERATION VERIFICATION

2-36. Amplitude Accuracy (Cont'd)

Maximum cumulative error:

0 to 60 dB, 0.01-18 GHz: $< \pm 2.4$ dB0 to 40 dB, 0.01-22 GHz: < 2.5 dB**PROCEDURE:**

1. Set all normal (green) settings, and other controls as follows:

FREQUENCY SPAN/DIV.....	1 MHz
RESOLUTION BW.....	30 kHz (coupled)
FREQUENCY BAND GHz.....	.01 – 1.8
TUNING.....	0.100 GHz
INPUT ATTEN.....	10 dB
REF LEVEL dBm.....	-10
REFERENCE LEVEL FINE.....	0
AMPLITUDE SCALE.....	1 dB LOG/DIV

2. Measure CAL OUTPUT signal level with a power meter. Specification: -10 dBm ± 0.3 dB.
3. Connect 100 MHz CAL OUTPUT signal through 355D step attenuator (set to 0 dB) to INPUT 50 Ω and tune spectrum analyzer to center signal on CRT display. Position peak of signal at REFERENCE LEVEL line with front-panel REF LEVEL CAL screwdriver adjustment.
4. To verify correct operation of the REFERENCE LEVEL FINE (Vernier) control, set 355D step attenuator to 10 dB. Set REFERENCE LEVEL FINE to -9 . The peak of the signal on the CRT display should be one division below the REFERENCE LEVEL ± 0.5 division ($< \pm 0.5$ dB). Return 355D step attenuator to 0 dB.
5. Set INPUT ATTEN to 70 dB, REF LEVEL dBm to 0, REFERENCE LEVEL FINE to -8 , RESOLUTION BW to 3 kHz, FREQUENCY SPAN/DIV to 1 kHz, and VIDEO FILTER to .03. Center signal on CRT display with TUNING control.
6. Adjust REF LEVEL CAL to position signal peak two divisions below REFERENCE LEVEL line.
7. Step instrument INPUT ATTEN from 70 to 0 dB while stepping 355D step attenuator from 0 to 70 dB (maintain a total attenuation of 70 dB). For each 10 dB step, the signal amplitude should not change more than ± 1 dB from the previous step. The total amplitude variation (difference between maximum and minimum signal levels over entire 70 dB range) should not exceed 2.4 dB.
8. Adjust REF LEVEL CAL to position signal peak two divisions below REFERENCE LEVEL line.
9. Step instrument REF LEVEL dBm from -70 to -10 while stepping 355D step attenuator from 70 dB to 10 dB (maintain signal level approximately two divisions below REFERENCE LEVEL line ± 0.5 divisions (± 0.5 dB)).

Table 2-4. Operation Verification Test Record

Hewlett-Packard Company Model 8569A Serial Number _____		Tested by _____ Date _____		
Para. No.	Test Description	Results		
		Min.	Actual	Max.
2-34	Calibrator Output Accuracy 2. 100 MHz	99.99	_____	100.01
2-34.	Tuning Accuracy 4b. 1.8 GHz 4d. 3.0 GHz 4f. 4.0 GHz	1.795 2.994 3.992	_____ _____ _____	1.805 3.006 4.008
2-35.	Span Width Accuracy 4. 100 MHz FREQUENCY SPAN/DIV 5. 10 MHz FREQUENCY SPAN/DIV 6. 1 MHz FREQUENCY SPAN/DIV	-0.4 div -0.4 div -0.4 div	_____ _____ _____	+0.4 div +0.4 div +0.4 div
2-35.	Resolution Bandwidth Accuracy 9. 1 MHz RESOLUTION BW 11. 30 kHz RESOLUTION BW	4.25 div 2.55 div	_____ _____	5.75 div 3.45 div
2-36.	Calibrator Output Power 2. CAL OUTPUT Signal	-10.3 dBm	_____	-9.7 dBm
2-36.	Vernier (0-12 dB) 4. Vernier Accuracy	0.5 div	_____	1.5 div
2-36.	Input Attenuator Accuracy 7. Error Between Adjacent Settings 8. Error Over 60 dB Range		_____ _____	±1.0 div ±2.4 div
2-36.	Reference Level Variation 9. Reference Level Variation in LOG, 0 to -60 dB		_____	±0.5 div

SECTION III OPERATION

3-1. INTRODUCTION

3-2. This section is published separately as '8569A Spectrum Analyzer Operation,' HP Part No. 08569-90008. It describes typical applications of signal analysis and provides detailed instructions for both local (front-panel) and remote (HP-IB) operation.

3-3. A table of contents is provided at the beginning of this section.

3-4. ROUTINE MAINTENANCE

3-5. Fuses

3-6. The HP 8569A has nine fuses, eight of which are internal. Only the ac line fuse, located at the back of the instrument, may be replaced by the operator. The ac line cord should be disconnected from the power source, then the other end disconnected from the instrument. With the power cord removed, access to the fuse compartment is gained by sliding open the clear plastic cover on the power module. The fuse is removed by pulling the lever

inside the fuse compartment. Replace the blown fuse with a fuse of the correct rating and type for the ac line voltage selected. Fuse ratings for different voltages are indicated below the power module. Access to the other eight fuses requires removal of the covers of the instrument. The internal fuses should be replaced by a qualified service technician.

3-7. Air Filter

3-8. Inspect the air filter frequently and, if necessary, remove and clean it. To clean the filter, wash it in warm water and detergent. Thoroughly dry the filter before reinstalling it.

3-9. Unrestricted air flow within the instrument lengthens component life. Keep the air filter clean.

3-10. Calibration

3-11. Performance tests (Section IV) should be performed every six months to ensure that the instrument meets the specifications listed in Section I.



**HEWLETT
PACKARD**

8569A SPECTRUM ANALYZER OPERATION

Copyright © 1981, HEWLETT-PACKARD COMPANY
1400 FOUNTAIN GROVE PARKWAY, SANTA ROSA, CALIFORNIA, 95404, U.S.A.

HP Part No. 08569-90008

Printed: MARCH 1981

CONTENTS

Chapter	Page	Chapter	Page
INTRODUCTION	1	Modulation	31
Signal Analysis	1	Noise	35
BASIC DESCRIPTION	3	Electromagnetic Interference (EMI)	35
1 OPERATING THE HP 8569A	3	Swept-Frequency Response	37
Line Power On	3	5 HP-IB REMOTE OPERATION	39
Front Panel Adjustment Procedure	3	APPENDIX A	
Getting Started	4	OPERATING PRECAUTIONS	42
Normal Settings	4	Low Impedance AC	42
Three-Knob Operation	5	DC Precautions	42
Simplified Signal Analysis	5	APPENDIX B	
Glossary	8	THEORY OF OPERATION	43
2 FRONT PANEL OPERATION	10	Systems Description	43
Tuning	10	RF Section	43
Frequency Span Mode	10	Automatic Stabilization Section	43
Resolution Bandwidth	12	IF Section	44
Reference Level	12	Digital Storage Display	44
Digital Storage Display	15	Tuning Control Section	44
Traces	15	APPENDIX C	
Trace Memory	17	AMPLITUDE CONVERSIONS	47
Direct Plotter Output	19	Conversion Equations	47
3 SPECIAL TOPICS	21	APPENDIX D	
Maximum Dynamic Range	21	OPTION STATUS INTERFACE	48
Improving Amplitude Measurement		APPENDIX E	
Accuracy	25	HP 8569A SYNTAX REFERENCE GUIDE	49
CRT Photography and X-Y Recording	25		
External Mixer Operation	26		
4 TYPICAL MEASUREMENTS	30		
Distortion	30		

INTRODUCTION

SIGNAL ANALYSIS

The spectrum analyzer is a receiver that displays signals in the frequency domain. The CRT on the analyzer displays signal amplitude (A) on the vertical axis and frequency (f) on the horizontal axis. A method of visualizing how a spectrum analyzer views the frequency domain is to picture a tunable bandpass filter that scans the frequency axis (see Figure 1). At any instant in time, the analyzer views only the signal it is tuned to receive, rejecting all others. In this way, all the individual

components of a signal are viewed separately. In comparison, an oscilloscope displays the signals in the time domain and the amplitude displayed represents the vector sum of all signal components.

The purpose of this section is to acquaint the reader with the operation of the Model HP 8569A Spectrum Analyzer. Rather than discussing specific topics in detail, the reader is referred to existing application notes, which may be obtained by contacting your local Hewlett-Packard Sales Office.

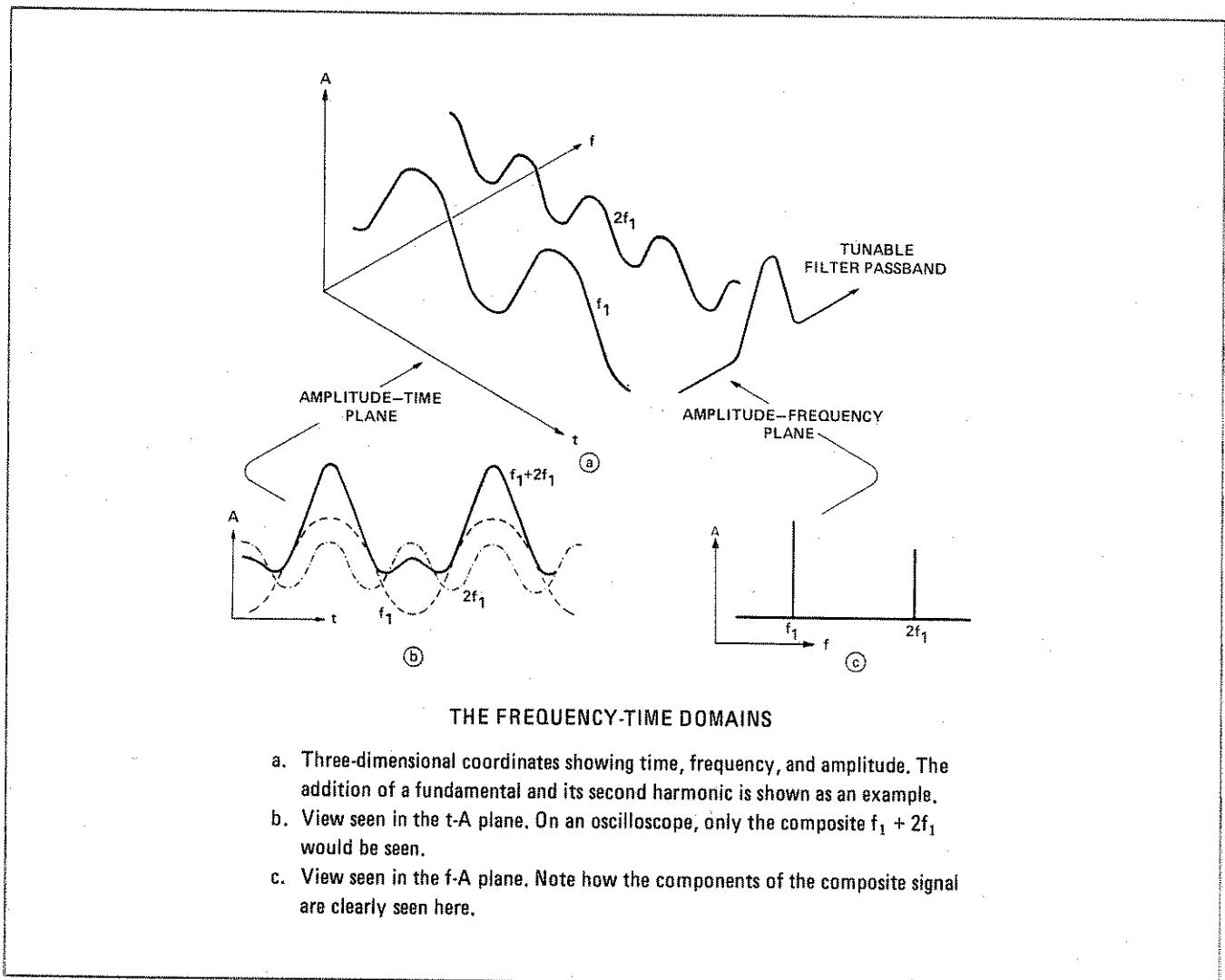

Figure 1. Frequency and Time Domain

BASIC DESCRIPTION

The HP 8569A (Figure 2) is a high-performance spectrum analyzer designed for ease of use. Most measurements can be made with just three controls once the normal (green) settings are preset. The HP 8569A has absolute amplitude and frequency calibration from 0.01 to 22 GHz. The frequency span, bandwidth, and video filter are all coupled with automatic sweep to maintain a calibrated display and simplify use of the analyzer. Internal preselection eliminates most spurious responses to simplify signal identification. The preselector also extends the dynamic range of the analyzer and provides some protection for the input mixer.

The HP 8569A has a digital storage display system. All the information necessary to analyze a signal is displayed on the top portion of the CRT. The trace information for both Trace A and Trace B resides in a

digital storage buffer which is updated at the sweep rate of the analyzer. The information in this buffer is then displayed on the CRT and automatically refreshed at a flicker-free rate. Certain arithmetic and logical functions, such as digital averaging and normalization, can be performed on the trace values. The graticule, character, and trace information can be output directly to a digital plotter set for the listen only mode without the need for a controller. A controller connected via HP-IB may be used to either output or input display information (e.g., trace values, text, control information).

The frequency range of the HP 8569A is 10 MHz to 22 GHz in direct coaxial input and 14.5 to 40 GHz when used with the HP 11517A External Mixer. Signal analysis above 40 GHz is possible with other commercially available external mixers.

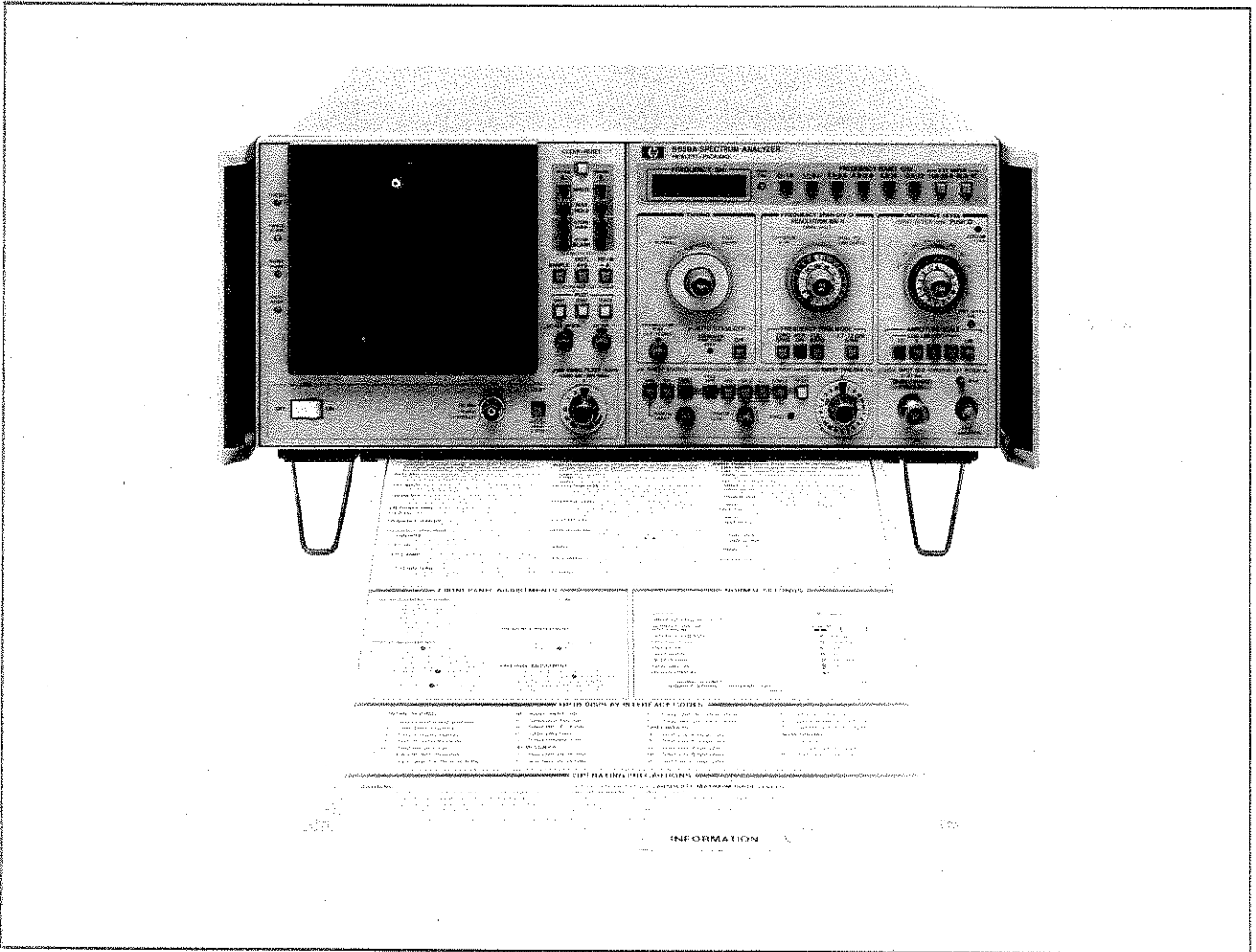

Figure 2. HP 8569A Spectrum Analyzer

CHAPTER 1 OPERATING THE HP 8569A

LINE POWER ON

CAUTION

Before connecting the line power cord, make sure the proper line voltage and line fuse have been selected for the instrument. For complete information on power cords, voltage and fuse selection, refer to the HP 8569A Operation and Service Manual, Section II.

When LINE is switched ON, the instrument performs an automatic internal instrument check. This routine checks the operation of the system memory (RAM), system program memory (ROM), and the stroke memory (RAM), located in the analyzer's display section. If the test routine fails partially or if the routine will not run at all, refer to the HP 8569A Operation and Service Manual, Section VIII.

Contained in the HP 8569A program memory (firmware) is a series of test patterns which aid in troubleshooting and in the adjustment of the analyzer. (Refer to HP 8569A Operation and Service Manual, Section VIII.)

FRONT PANEL ADJUSTMENT PROCEDURE

The front panel adjustment optimizes the performance of the HP 8569A Spectrum Analyzer to obtain its specified accuracy. The following step-by-step procedure is recommended for adjusting the HP 8569A. A condensed procedure is also located on a pull-out INFORMATION CARD attached to the analyzer.

Pre-adjustment Settings

1. Set normal (green) settings on analyzer (Table 1).
2. Set FREQUENCY BAND GHz to 0.01 – 1.8.
3. Set FREQUENCY SPAN/DIV to 1 MHz.
4. Set INPUT ATTEN to 10 dB.
5. Set REF LEVEL dBm to -10 and REFERENCE LEVEL FINE to 0 dB.

Table 1. Normal Settings

Function	Setting
TRACE A, B	<input type="checkbox"/> WRITE
SAMPLE, DGTL AVG, INP-B→A	<input type="checkbox"/> OUT
FREQUENCY SPAN/DIV RESOLUTION BW	OPTIMUM (Push in to couple) ▶ ◀
FREQUENCY SPAN MODE	<input type="checkbox"/> PER DIV
AMPLITUDE SCALE	<input type="checkbox"/> 10 dB
VIDEO FILTER	<input type="checkbox"/> OFF
SWEEP SOURCE	<input type="checkbox"/> INT
SWEEP TRIGGER	<input type="checkbox"/> FREE RUN
SWEEP TIME/DIV	<input type="checkbox"/> AUTO
PRESELECTOR PEAK	<input type="checkbox"/> Center in green area

Display Adjustments

1. Adjust FOCUS \odot for clearest control readout characters.
2. Press and hold in the GRAT while pressing the CLEAR/RESET to activate the Display Adjust line at top of screen as shown in Figure 3.

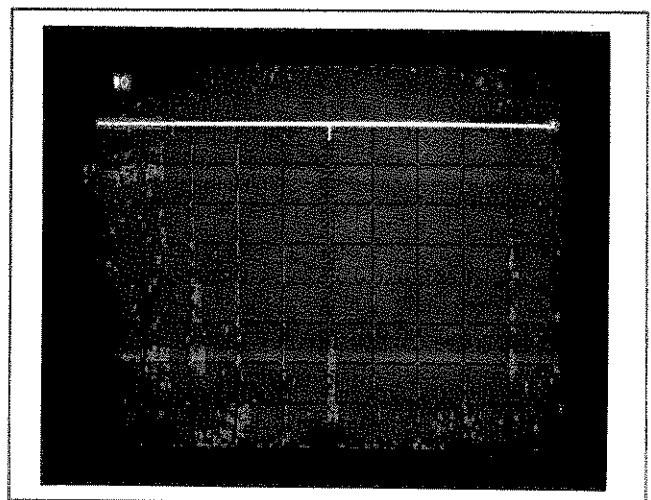

Figure 3. Display Line Adjustment

3. Adjust TRACE ALIGN \odot so that the displayed line is parallel to top graticule line.
4. Adjust VERT POSN \odot to place display line on top graticule line (REFERENCE LEVEL).
5. Adjust HORIZ POSN \odot to place center cross tic of displayed line at center of top graticule line.
6. Press CLEAR/RESET to return normal display.

Frequency Adjustment

1. Connect 100 MHz CAL OUTPUT signal to INPUT.
2. Center signal on CRT with TUNING control.
3. Uncouple the RESOLUTION BW and set it to 10 kHz.
4. Adjust FREQ CAL \odot to indicate 0.100 GHz on FREQUENCY GHz readout.

Amplitude Adjustment

1. Center signal on CRT with TUNING control.
2. While keeping signal centered on the CRT, reduce FREQUENCY SPAN/DIV to 50 kHz.
3. Set AMPLITUDE SCALE to 1 dB
4. Adjust REF LEVEL CAL \odot to position the peak of the signal on the REFERENCE LEVEL (top graticule line) of the CRT.
5. Reset the AMPLITUDE SCALE to 10 dB

Once the Front Panel Adjustment Procedure is completed, the CRT display should be similar to that shown in Figure 4.

The HP 8569A is now calibrated for absolute frequency and amplitude measurement.

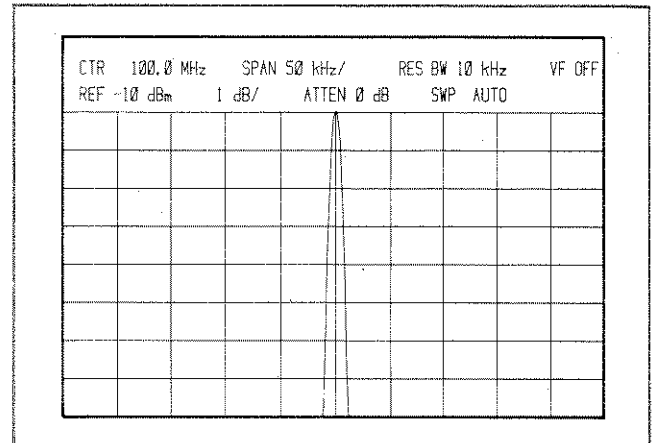

Figure 4. CAL OUTPUT Signal

GETTING STARTED

The HP 8569A Spectrum Analyzer is a sensitive measuring instrument. To avoid damage to the instrument, do not exceed the following:

Absolute Maximum Inputs:¹

Total RF Power: +30 dBm (1 watt)
 dc or ac (<< 50Ω source impedance):
 0V with 0 dB RF input attenuation (<1 amp)
 ±7V with ≥10 dB RF input attenuation (<0.14 amp).
 Peak Pulse Power:^{*}
 +50 dBm (<10 μsec pulse width, 0.01% duty cycle) with ≥20 dB INPUT ATTEN.

CAUTION

This instrument and any device connected to it must be connected to power line ground. Failure to ensure proper grounding could cause a shock hazard or damage to the instrument.

NORMAL SETTINGS

The normal settings are those settings which are used for the majority of measurements. For instance, 10 dB/division, INT sweep position, and AUTO sweep

¹For more detailed information regarding Operating Precautions refer to Appendix A.

Table 2. Normal Settings

Function	Setting
TRACE A, B	<input type="checkbox"/> WRITE
SAMPLE, DGTL AVG, INP-B→A	<input type="checkbox"/> OUT
FREQUENCY SPAN/DIV RESOLUTION BW	OPTIMUM (Push in to couple)
FREQUENCY SPAN MODE	<input type="checkbox"/> PER DIV
AMPLITUDE SCALE	<input checked="" type="checkbox"/> 10 dB
VIDEO FILTER	<input type="checkbox"/> OFF
SWEEP SOURCE	<input checked="" type="checkbox"/> INT
SWEEP TRIGGER	<input checked="" type="checkbox"/> FREE RUN
SWEEP TIME/DIV	<input type="checkbox"/> AUTO
PRESELECTOR PEAK	<input type="checkbox"/> Center in green area

time setting are most often used and so are classified as normal settings. All normal settings on the HP 8569A are colored green so the user can easily identify and set them initially. Table 2 lists all the green normal settings of the HP 8569A.

With normal settings, most measurements can be made using only the TUNING, FREQUENCY SPAN/DIV and REFERENCE LEVEL controls. The analyzer is calibrated for any combination of control settings as long as the UNCAL indicator is not displayed (refer to Chapter 2).

THREE-KNOB OPERATION

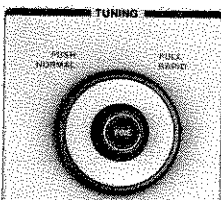

TUNING adjusts the center frequency of the analyzer. It also positions the marker in the full band and 1.7 to 22 GHz span modes.

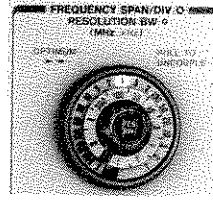

FREQUENCY SPAN/DIV sets the horizontal frequency calibration on the CRT. An optimum resolution bandwidth is automatically selected for a given frequency span.

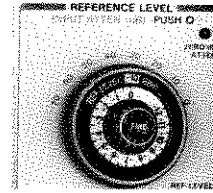

The REFERENCE LEVEL control sets the vertical amplitude calibration on the CRT. The REFERENCE LEVEL (top graticule line) on the CRT represents an absolute power level (in dBm or dBμV). Changes in RF INPUT ATTEN will also change the indicated REFERENCE LEVEL.

SIMPLIFIED SIGNAL ANALYSIS



The internal CAL OUTPUT signal is a convenient source to demonstrate how fast and easily the HP 8569A can measure frequency and amplitude.

Start by presetting the green normal settings listed in Table 2. This sets the analyzer in its normal, three-knob operation mode. Now connect the CAL OUTPUT signal to the INPUT connector of the analyzer and begin the measurement procedure:

1. Select the FREQUENCY BAND that includes the 100 MHz CAL OUTPUT signal (.01 – 1.8).
2. Use the TUNING control to tune the 100 MHz signal to the center of the display. The FREQUENCY SPAN/DIV control may be increased to facilitate tuning.
3. Adjust the FREQUENCY SPAN/DIV control to achieve the desired resolution. Since there is no modulation on the CAL OUTPUT signal, a 1 MHz/Div span is sufficient. Retune the signal to the center of the display if necessary.
4. Position the peak of the signal on the REFERENCE LEVEL (top graticule line) of the CRT using the REFERENCE LEVEL control.

Since the CAL OUTPUT signal is the calibration reference for the analyzer, FREQUENCY GHz should read 0.100 GHz and the REFERENCE LEVEL should read -10 dBm (Figure 5). If not, adjust the FREQ CAL and the REF LEVEL CAL to obtain the correct reading.²

For this next example, let us suppose that the microwave source in the test setup (Figure 6) operates in C-band (4 to 8 GHz). However, we do not know its exact output frequency. What, then, is the best way for locating a signal?

By using the full band feature of the HP 8569A, we can sweep an entire frequency band to search for a signal.

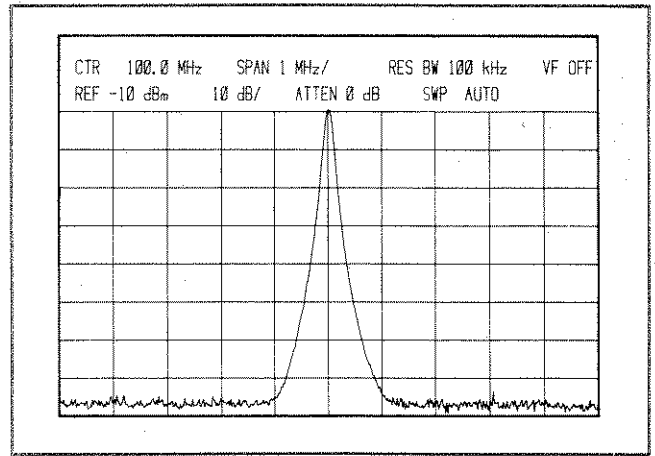

Figure 5. CAL OUTPUT Signal

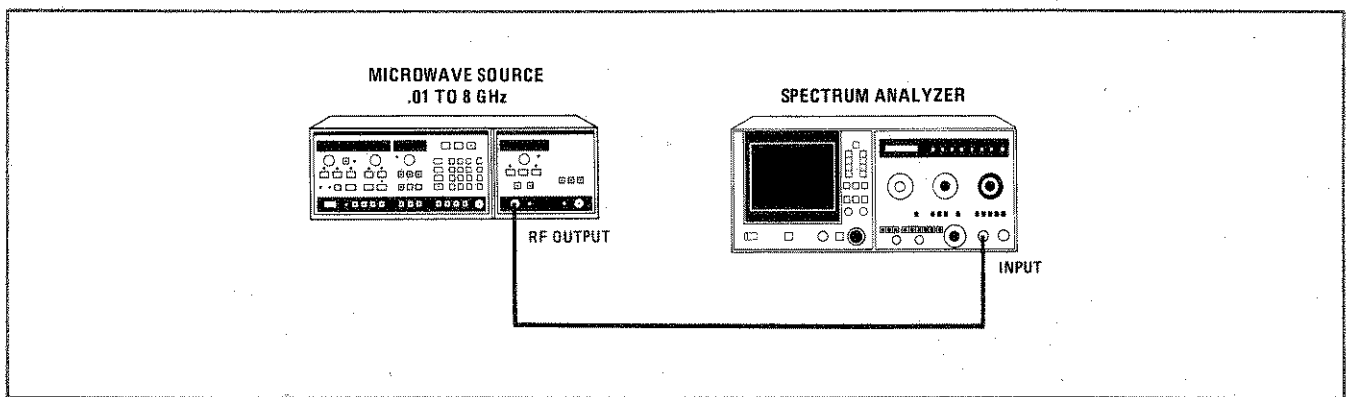

Figure 6. Microwave Source Test Setup

Since we know that the microwave source in Figure 6 operates in C-band, the 3.8 to 8.5 GHz Frequency Band would be selected. A tuning marker (which appears in

the full band modes) can be located under the signal to identify its frequency (Figure 7). Then by pushing the green PER DIV button, the signal at the marker will become the center frequency of the analyzer (Figure 8). In per div the desired frequency span can be adjusted with the FREQUENCY SPAN DIV control. Figure 9 illustrates the procedure for locating a signal.

² A complete front panel adjustment procedure is included in this chapter.

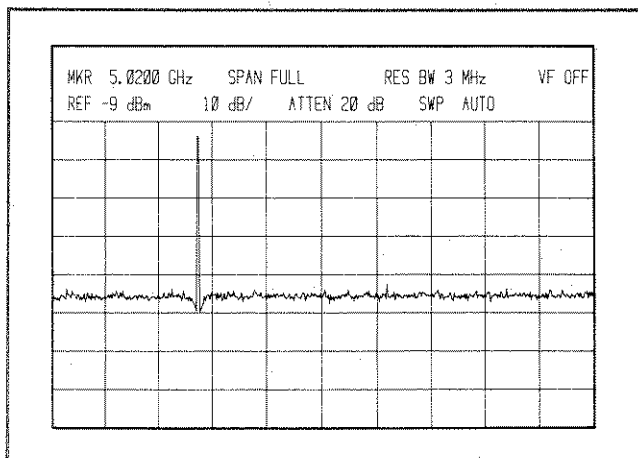

Figure 7. Tuning Marker in FULL BAND

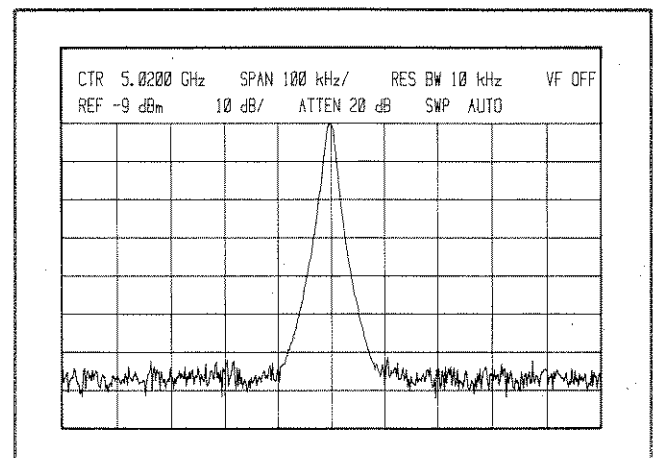
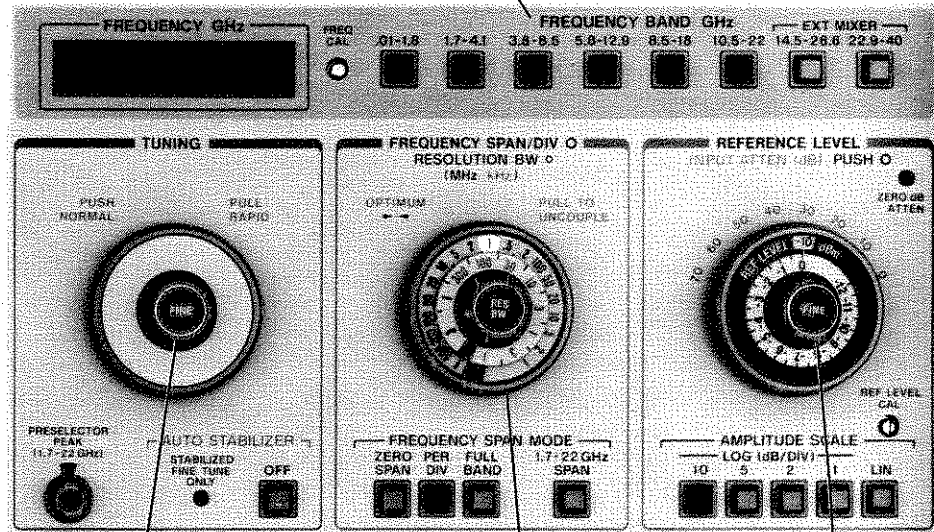

Figure 8. PER DIV Mode

1 Set desired FREQUENCY BAND while
in FULL BAND Frequency Span Mode



2 TUNING Control sets
marker which will be
center frequency in
PER DIV MODE

3 Reset to PER DIV and
adjust FREQUENCY
SPAN/DIV

4 Position signal on
top REFERENCE
LEVEL line

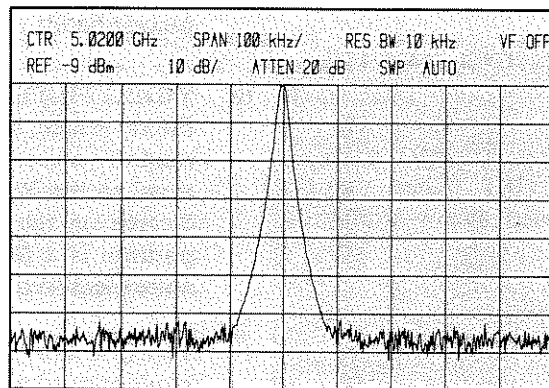

Figure 9. Locating a Signal

CONTROL GLOSSARY

Front Panel

1. **LINE:** AC line switch. Turns instrument primary power ON-OFF.
2. **FOCUS:** Adjusts sharpness of CRT trace.
3. **TRACE ALIGN:** Rotates trace about center of CRT.
4. **HORIZ POSN:** Adjusts horizontal position of CRT trace.
5. **VERT POSN:** Adjusts vertical position of CRT trace.
6. **CLEAR RESET:** Clears trace data in WRITE and MAX HOLD operation and resets sweep. Resets digital averaging routine to begin average of subsequent sweeps. Also resets INP—B—A operation. Aborts plot during any plot mode. Returns HP-IB display interface to local control.
7. **TRACE A, B:** Provides two independent digital traces in the following modes.
 - a. **WRITE:** Displays current input signal with each sweep.
 - b. **MAX HOLD:** Displays only the highest value of trace data over successive sweeps. Process restarted by pressing CLEAR/RESET .
 - c. **STORE VIEW:** Stores current trace and displays it on CRT.
 - d. **STORE BLANK:** Stores current trace without displaying it on CRT. When both STORE BLANK are pressed, analog display appears.
8. **SAMPLE:** Selects sample detection mode for random noise measurements (see Chapter 2).
9. **DGTL AVG:** Digitally averages trace data over successive sweeps. Maximum averaging achieved after 64 sweeps. Sample detection mode automatically selected.
10. **INP—B—A:** Subtracts trace data stored in TRACE B from input signal data and displays resulting data in Trace A. Normalized trace is at the center horizontal graticule line when input signal is equal to stored Trace B (See Chapter 2). Center line reference level (MID) changes to dB for relative measurements.
11. **PLOT:** Provides control of HP-IB plotter set for Listen Only mode. Display information is frozen on screen during plot. Use CLEAR/RESET to abort plot and return to local control.
 - a. **GRAT** plots graticule.
 - b. **CHAR** plots CRT control readouts or HP—IB entered message.
 - c. **TRACE** plots displayed trace(s).
12. **SCALE INTEN:** Adjusts background illumination for photography. Set to blue area for CRT photographs. Does not operate in ANALOG DSPL mode.
13. **INTEN:** Adjusts brightness of CRT trace and characters. Set to the blue region for CRT photographs.
14. **CAL OUTPUT:** An internal 100 MHz, -10 dBm (+97 dB μ V) calibration signal.
15. **SIG IDENT:** Used to verify frequency of unknown signals. Especially useful in External Mixing bands.
16. **VIDEO FILTER:** Selects post-detection, low-pass filters which smooth the trace by averaging random noise. The Video Filter bandwidth is equal to the Resolution BW times the factor indicated on the control knob. The NOISE AVG position is a fixed 1 Hz low-pass filter used for noise measurements only.
17. **FREQ CAL:** Calibrates the FREQUENCY GHz readout to a known frequency reference.
18. **FREQUENCY GHz:** Displays the tuned center frequency of analyzer in PER DIV and ZERO SPAN. In Full Band modes, displays frequency of the tuning marker.
19. **FREQUENCY BAND GHz:** Selects frequency range.

20. TUNING: Tunes center frequency of analyzer or positions tuning marker in Full Band mode.
21. PRESELECTOR PEAK: Adjusts tracking of internal preselector. Normally centered in green area for best broadband performance from 1.7 to 22 GHz. Used to maximize signals for more accurate amplitude measurements.
22. AUTO STABILIZER: Analyzer is automatically stabilized for narrow frequency spans (≤ 100 kHz/division). In stabilized mode, light is on and only FINE tuning should be used. Pushbutton switch (when depressed) disables AUTO STABILIZER to allow coarse tuning in narrow spans.
23. FREQUENCY SPAN/DIV: Selects CRT horizontal axis frequency calibration in PER DIV mode.
24. RESOLUTION BW: Selects analyzer 3 dB IF bandwidth. Convenient resolution bandwidth for any frequency span automatically selected when green markers ($\blacktriangleright \blacktriangleleft$) are aligned and controls pushed in to couple.
25. FREQUENCY SPAN MODE: Selects desired span mode.
 - a. ZERO SPAN: Analyzer operates as a manually tuned receiver to display detector output in the time domain. The SWEEP TIME/DIV control is a calibrated time base when switched out of AUTO position.
 - b. PER DIV: Allows FREQUENCY SPAN/DIV control to select desired frequency span. With FREQUENCY SPAN/DIV control in F (Full Band), entire Frequency Band selected is displayed. A tuning marker, selectable resolution bandwidth, and video filter are available in the F position.
 - c. FULL BAND: Spans the entire Frequency Band selected. A tuning marker is available and 3 MHz resolution bandwidth and 9 kHz video bandwidth are automatically selected.
 - d. 1.7–22 GHz SPAN: Analyzer spans 1.7–22 GHz in one sweep. A tuning marker is available and 3 MHz resolution bandwidth and 9 kHz video bandwidth are automatically selected.
26. REFERENCE LEVEL: Controls power level represented by top graticule line of CRT. Adjustable in calibrated 10 dB steps with continuous calibrated 0 to -12 dB FINE vernier. Display readout can be set to either dBm or $\text{dB}\mu\text{V}$ with internal jumper (refer to Appendix D).
27. INPUT ATTEN: Push and turn to select desired RF input attenuation indicated by blue numbers. A reminder light indicates zero dB input attenuation. Greater than 10 dB of input attenuation provides best input match and maximum input protection.
28. AMPLITUDE SCALE: Selects log (dB division) or linear vertical scale calibration. Reference level remains constant at top graticule line except for INP—B—A operation (refer to Chapter 2).
29. REF LEVEL CAL: Calibrates reference level to a known amplitude reference.
30. SWEEP SOURCE: Selects desired sweep source.
 - a. MNL: Provides real time display of signal amplitude at any frequency within displayed frequency span. Sweep controlled with MANUAL SWEEP knob. Digital traces are blanked during MNL operation.
 - b. EXT: Allows analyzer to be swept with external source.
 - c. INT: Analyzer sweeps repetitively with internal sweep source. Synchronization selected by SWEEP TRIGGER.
31. SWEEP TRIGGER: Selects trigger source for INT sweep.
 - a. FREE RUN: Sweep triggered repetitively by internal source.
 - b. LINE: Sweep triggered by AC line frequency.
 - c. VIDEO: Sweep internally triggered by detected waveform of RF signal.
 - d. EXT: Sweep triggered by external signal.
 - e. SINGLE: Sweep triggered or reset by START/RESET pushbutton.
 - f. START/RESET: Dual function pushbutton can start a single sweep or reset any internal sweep back to left edge of CRT.

- g. TRIGGER LEVEL: Adjusts trigger level in Video or Ext Trigger mode. DC coupled, positive slope triggering.
 - h. SWEEP: Light is on while analyzer is sweeping.
32. SWEEP TIME/DIV: Selects time required to sweep one major horizontal division on CRT. AUTO position automatically selects fastest sweep time as a function of FREQUENCY SPAN/DIV, RESOLUTION BW, and VIDEO FILTER settings to maintain a calibrated amplitude display.
33. INPUT 50Ω: Type N female connector with 50Ω input impedance. Used for signals from 0.01 to 22 GHz.

CAUTION

MAXIMUM INPUT is +30 dBm (1 watt) and 0 volts D.C. (Refer to Operating Precautions.)

- 34. EXT MIXER: 50Ω SMA input/output port for use with external mixers for waveguide measurements above 22 GHz. Adjust BIAS to maximize signal amplitude.
- 35. EXT MIXER BIAS: Controls amount of dc bias to HP 11517A mixer diode, or any non self-biasing mixer diode. Adjust to maximize signal amplitude.
- 36. INFORMATION CARD: Pull out to use. Card provides basic HP-IB and reference information.
- 37. CRT Annotation: Displays all major spectrum analyzer settings (see Chapter 2).

Rear Panel

- 38. HORIZONTAL SWEEP Output (X-axis): A -5.0V to +5.0V output which is proportional to horizontal CRT deflection from left to right, respectively; 0.0V corresponds to center of CRT. Output impedance is 5 kΩ. Used for driving horizontal channel of X-Y recorder or other external monitors.
- 39. VERTICAL OUTPUT (Y-axis): A 0 to +0.8V detected video output which is proportional to vertical deflection on CRT. 0V corresponds to bottom graticule line and +0.8V corresponds to top graticule line. Output impedance is 50Ω. Used

for driving vertical channel of X-Y recorder or other external monitors. Also useful in Zero Span for listening to detected output with headphones.

- 40. BLANK OUTPUT (PENLIFT) (Z-axis): A 0 or 15V output which corresponds to CRT blanking during retrace and oversweeping of band edges. During unblank period (pen down) output is 0V with 10Ω output impedance.

CAUTION

Maximum current sink 150 ma.

During Blank (pen up), output is +15V with 10 kΩ output impedance. Used to control pen lift of X-Y recorder or blanking of other external monitor.

- 41. EXT SWEEP INPUT: With SWEEP SOURCE in EXT, a 0 to +10V ramp sweeps analyzer across frequency span selected. Ramp duration must be >70 msec (>110 msec with DGTL AVG selected).

CAUTION

Maximum input level is ±40V. Input impedance is 100 kΩ.

- 42. EXT TRIGGER INPUT: With SWEEP TRIGGER in EXT, a positive voltage ≥1V triggers internal sweep source. TRIGGER LEVEL adjusts point (from 1 to 10V) on trigger waveform which starts sweep. DC coupled, positive-slope triggering.

CAUTION

Maximum input is ±40V. Input impedance is 100 kΩ.

- 43. BLANKING INPUT: Permits external blanking control of CRT. TTL compatible; high (≥2V) blanks CRT; low (<0.5V) or an open circuit retains normal CRT operation. Note that in Digital Storage Display mode, Blanking Input does not directly blank the CRT (see Retrace).

CAUTION

Maximum input is ±40V. Input impedance is 10 kΩ.

- 44. RETRA... input is n Storage (>2V) i circuit m must be >

Maximum pedance

- 45. 1st LO C nominal t Terminat to Apper Frequenc

- 46. 21.4 MF linearly Bandwid BW sett ATTEN, REFERE to -60 d is approx on CRT.

- 47. ADDRESS to be use address i A5 = 16,

- 48. HP-IB C Bus allo Program

- 49. AUX B factory c

- 50. Power L allows ch -10%). module.

A 3 amp for 100 o normal b or 240V o

44. RETRACE: With SWEEP SOURCE in EXT, this input is necessary to initiate sweep when in Digital Storage Display mode. TTL compatible; high (>2V) initiates sweep; low (<0.5V) or open circuit maintains normal operation. Pulse width must be > 20 msec.

CAUTION

Maximum input is $\pm 40V$. Input impedance is 10 k Ω .

45. 1st LO OUTPUT: A 2.0 to 4.46 GHz, +8 dBm nominal output coupled from first local oscillator. Terminate with 50 Ω load when not in use. (Refer to Appendix B for information on LO for each Frequency Band.)

46. 21.4 MHz IF OUTPUT: A 21.4 MHz output linearly related to the RF input to analyzer. Bandwidth controlled by analyzer RESOLUTION BW setting. Amplitude controlled by INPUT ATTEN, REF LEVEL FINE and first six REFERENCE LEVEL step gain positions (-10 to -60 dBm with 0 dB INPUT ATTEN). Output is approximately -10 dBm for full-scale signals on CRT. Output impedance is 50 Ω .

47. ADDRESS: Determines address of the instrument to be used for communications via HP-IB. The address is set as the sum of the switches, where A5=16, A4=8, A3=4, A2=2, A1=1.

48. HP-IB Connector: The Hewlett-Packard Interface Bus allows remote operation of the analyzer. Programming codes are summarized in Chapter 5.

49. AUX B Connector: Interconnection jack for factory calibration of analyzer.

50. Power Line Module: Line voltage selector card allows choice of 100, 120, 220, or 240 volts (+5%, -10%). Line fuse contained in power line module.

WARNING

A 3 amp normal blow fuse must be used for 100 or 120V operation and a 1.5 amp normal blow fuse must be used for 220 or 240V operation.

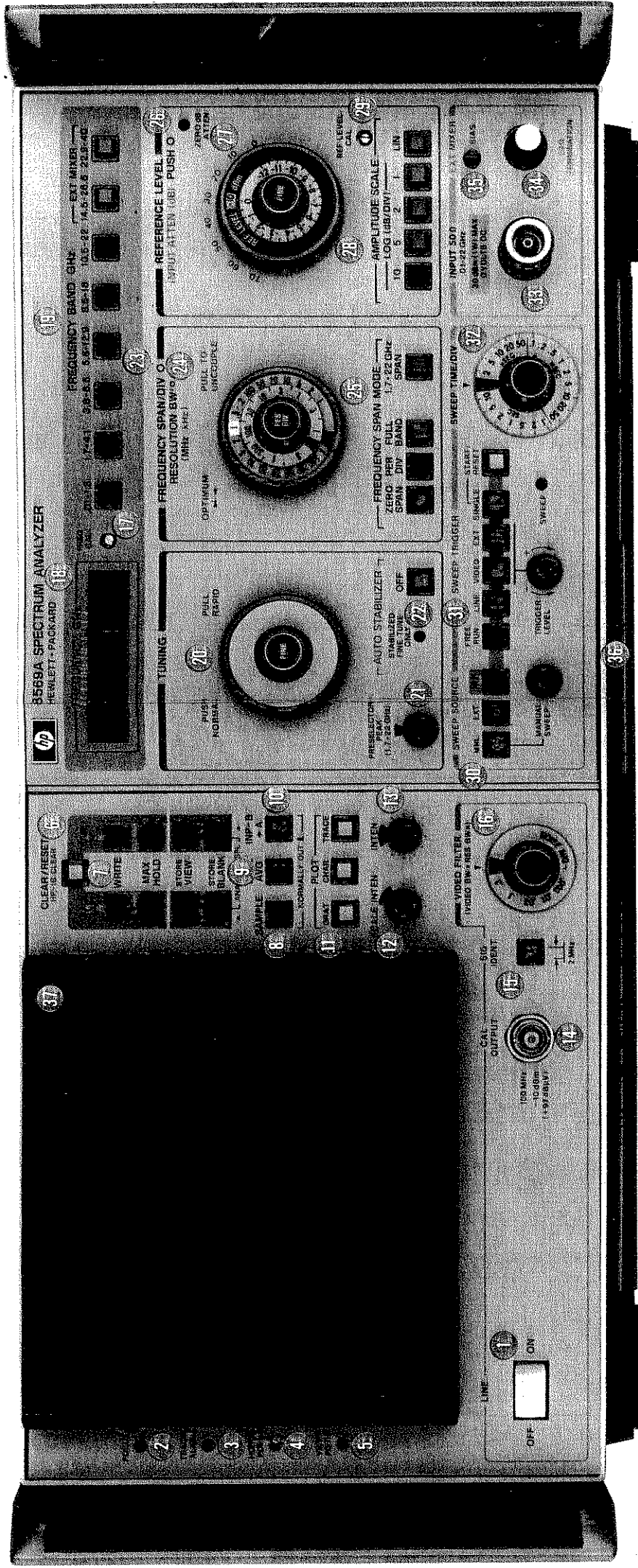

Figure 10. HP 8569A Front Panel

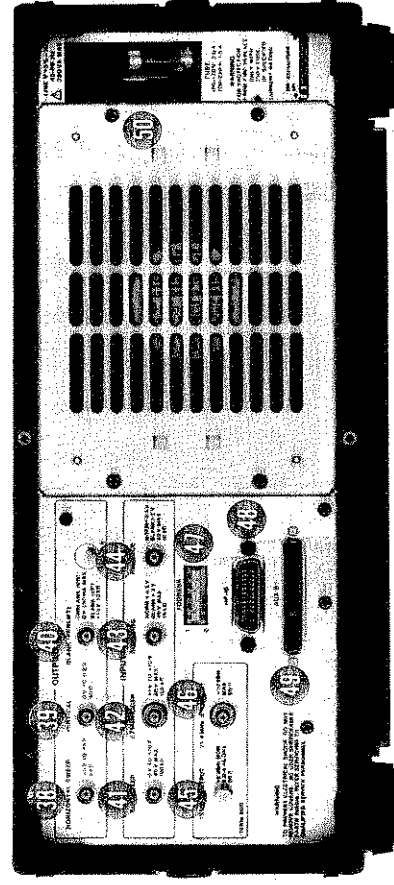
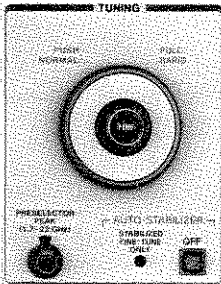

Figure 11. HP 8569A Rear Panel

CHAPTER 2 FRONT PANEL OPERATION

This chapter provides detailed descriptions of all front-panel controls. Following each description, the relevant HP-IB code is given. For additional HP-IB information, refer to Chapter 5 and Appendix E.

TUNING



The TUNING control adjusts the center frequency of the analyzer. In the full-band modes, the TUNING control is used to locate an inverted marker on a particular signal. The FREQUENCY GHz readout on the front panel and the CTR readout on the display indicate the center frequency of the analyzer or the frequency at the tuning marker. By pulling out

the outer control rapid tuning is enabled. Rapid tuning is especially useful when moving the tuning marker in full band modes. Normal tuning resumes when the knob is pushed in. When the analyzer is stabilized (frequency spans ≤ 100 kHz/Div), only FINE TUNING should be used to tune the analyzer. If coarse tuning is desired, the AUTO STABILIZER can be disabled with the push-button switch.

HP-IB Code:

CF (output center frequency)

FREQUENCY SPAN MODE



Four pushbutton span modes are available on the HP 8569A: ZERO SPAN, PER DIV, FULL BAND, and 1.7–22 GHz SPAN.

An additional F (full-band) setting is available on the FREQUENCY SPAN/DIV control knob. The full-band modes (FULL BAND, F, and 1.7–22 GHz) enable the analyzer to monitor the various frequency bands or to provide multiband coverage from 1.7 to 22 GHz. PER DIV mode is generally used for detailed signal analysis, and ZERO SPAN is used for time domain analysis. The following text explains the various FREQUENCY SPAN MODE settings in more detail.

HP-IB Code:

SP (output FREQUENCY SPAN/DIV)

Zero Span

ZERO SPAN is used to recover the modulation on a carrier. In this mode, no sweep voltage is applied to the LO in the analyzer, so it operates as a manually tuned narrowband receiver. Carrier modulation is displayed in the time domain, and the calibrated SWEEP TIME/DIV control can be set manually to read the time variation of the signal. Selection of VIDEO trigger allows the sweep to be synchronized on the demodulated waveform. Figure 12 illustrates a demodulated AM carrier that was obtained with the analyzer in ZERO SPAN.

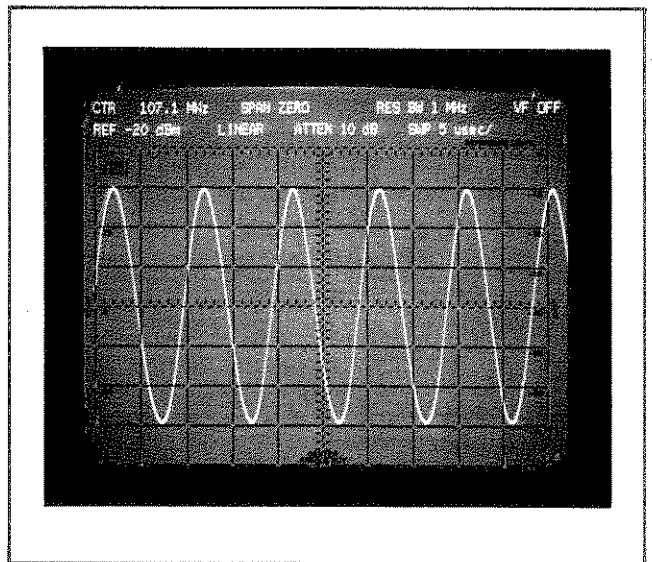

Figure 12. AM Carrier Demodulated in ZERO SPAN

Since the analyzer remains calibrated in ZERO SPAN, it is also possible to measure the amplitude and frequency of a CW signal. In this case, the CW signal appears as a horizontal line on the CRT. (See Figure 13.) Use a wide RESOLUTION BW setting and disable the AUTO STABILIZER for ease of tuning the signal.

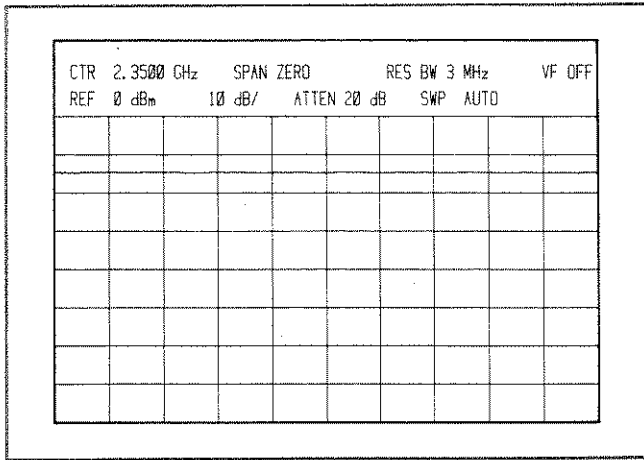

Figure 13. CW Measurement in ZERO SPAN

Per Div

The PER DIV mode enables the FREQUENCY SPAN/DIV control to set the horizontal frequency calibration of the CRT. The calibrated FREQUENCY SPAN/DIV control is adjustable from 1 kHz/Div to 500 MHz/Div in a 1, 2, 5 sequence of steps. An F (full-band) position allows the entire Frequency Band selected to be scanned. Normally, the RESOLUTION BW is coupled (◀▶) to the FREQUENCY SPAN/DIV so that the optimum RESOLUTION BW setting is automatically selected as the FREQUENCY SPAN/DIV is adjusted.

Full Band

The FULL BAND mode scans in one sweep the entire selected Frequency Band. A tuning marker, 3 MHz Resolution BW and 0.003 Video Filter are automatically set in Full Band. Different Frequency Bands can be selected to look for unknown signals. Once a signal is located in a particular Frequency Band, the tuning marker can be positioned under the signal to identify its frequency (Figure 14). Then, by pushing PER DIV, the signal that was at the marker will be displayed at the center frequency on the CRT (Figure 15). The F position on the FREQUENCY SPAN/DIV control differs from the FULL BAND pushbutton in that it allows independent adjustment of the RESOLUTION BW and VIDEO FILTER controls.

1.7 – 22 GHz Span

A multiband sweep, available when the 1.7–22 GHz SPAN pushbutton is depressed, is useful for observing signal activity within a broad frequency range. A tuning marker can be used with rapid tuning to quickly identify

the frequency of any signal in the 1.7–22 GHz range. Figure 16 illustrates a typical display with the 1.7–22 GHz SPAN selected.

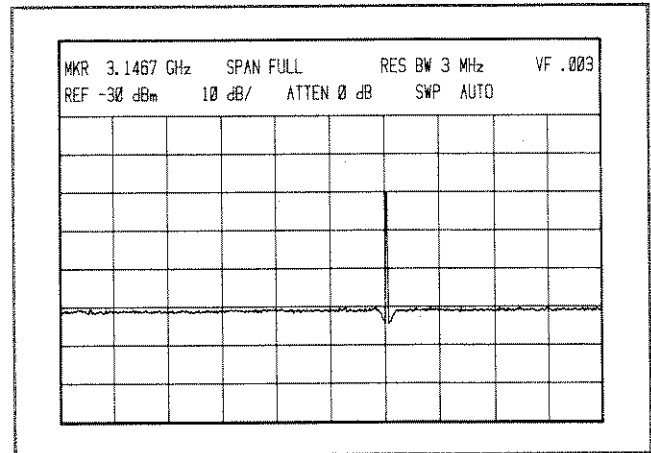

Figure 14. Identifying a Signal in FULL BAND

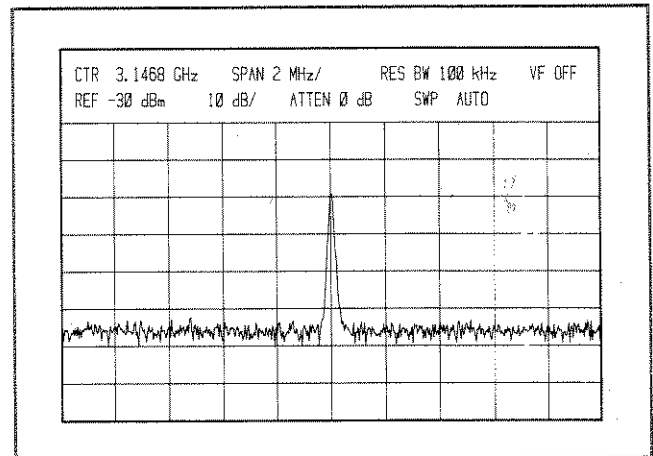

Figure 15. Analysis in PER DIV

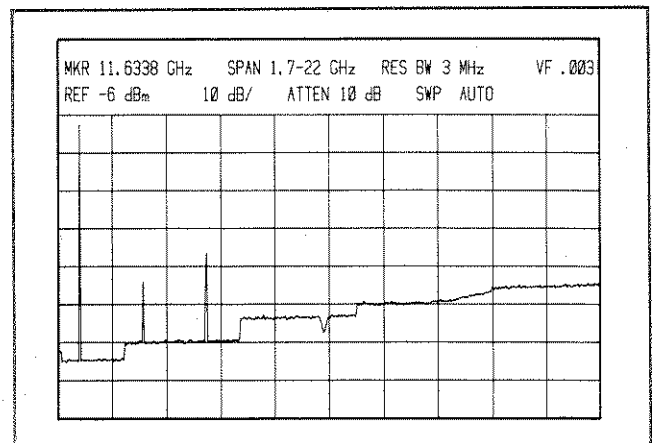
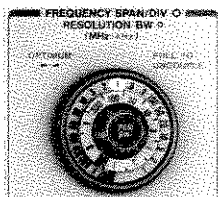

Figure 16. 1.7–22 GHz SPAN Mode

The stair-step baseline display in Figure 16 is the result of gain compensation applied to the higher frequency bands to maintain a calibrated amplitude display. Gain compensation is required because the higher frequency bands utilize higher LO harmonics of lower amplitude, yielding reduced sensitivity. To obtain the highest sensitivity from the analyzer, use the lowest FREQUENCY BAND GHz setting available when there is a frequency overlap. For instance, a 7 GHz signal can be measured in the 3.8 to 8.5 GHz band or the 5.8 to 12.9 GHz band. The sensitivity, however, is better in the 3.8 to 8.5 GHz band.

The five frequency span modes available on the HP 8569A provide the user with maximum flexibility in making measurements. Table 3 summarizes the characteristics of each FREQUENCY SPAN MODE setting.

RESOLUTION BANDWIDTH



In OPTIMUM setting, the RESOLUTION BW is coupled to the FREQUENCY SPAN/DIV by aligning the green markers (▶◀) and pushing the controls in. Once the controls are coupled at OPTIMUM, the best RESOLUTION BW setting will be

automatically chosen for any frequency span selected. The RESOLUTION BW control can also be coupled at a position other than OPTIMUM without loss of calibration of the spectrum analyzer. Calibration is

always ensured when the UNCAL indication on the CRT annotation is not present.

For certain applications, independent control of the RESOLUTION BW control may be desirable. When either control knob is pulled out, the RESOLUTION BW control is decoupled, allowing different Resolution BW settings to be selected. Figure 17 illustrates how an AM signal with 200 kHz sidebands is displayed at various RESOLUTION BW control settings. Note that the narrower Resolution BW will yield increased sensitivity, since random noise decreases 10 dB for every factor of 10 reduction in Resolution BW.

The SWEEP TIME/DIV control, when in AUTO position, will automatically select the proper sweep speed whether the RESOLUTION BW control is coupled or uncoupled.

HP-IB Code:

RB (output RESOLUTION BW)

REFERENCE LEVEL

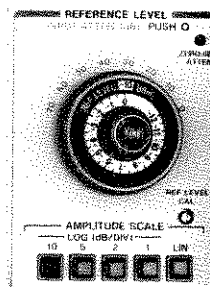

The main purpose of the REFERENCE LEVEL control is to set the absolute power at the REFERENCE LEVEL (top graticule line) on the CRT. When the peak of a signal is at the REFERENCE LEVEL, its absolute level (in dBm or dBμV) is indicated on the CRT annotation as well as on the REFERENCE LEVEL con-

Table 3. Frequency Span Modes

	Full Band Modes				
	ZERO SPAN <input type="checkbox"/> (Time Domain)	PER DIV <input type="checkbox"/> (Close Analysis)	<input type="checkbox"/> On Freq Span/Div Control	FULL BAND <input type="checkbox"/>	1.7-22 GHz SPAN <input type="checkbox"/>
TUNING MARKER	NO	NO	YES	YES	YES
FREQUENCY SPAN	ZERO (Manual Tune)	Selectable from 1 kHz/DIV to 500 MHz/DIV	Depends on FREQUENCY BAND selected	Depends on FREQUENCY BAND selected	1.7 to 22 GHz
RESOLUTION BANDWIDTH	Selectable	OPTIMUM ▶◀ or Selectable	Selectable	Fixed at 3 MHz	Fixed at 3 MHz
VIDEO FILTER	Selectable	Selectable	Selectable	Fixed at 0.003 x 3 MHz = 9 kHz	Fixed at 0.003 x 3 MHz = 9 kHz

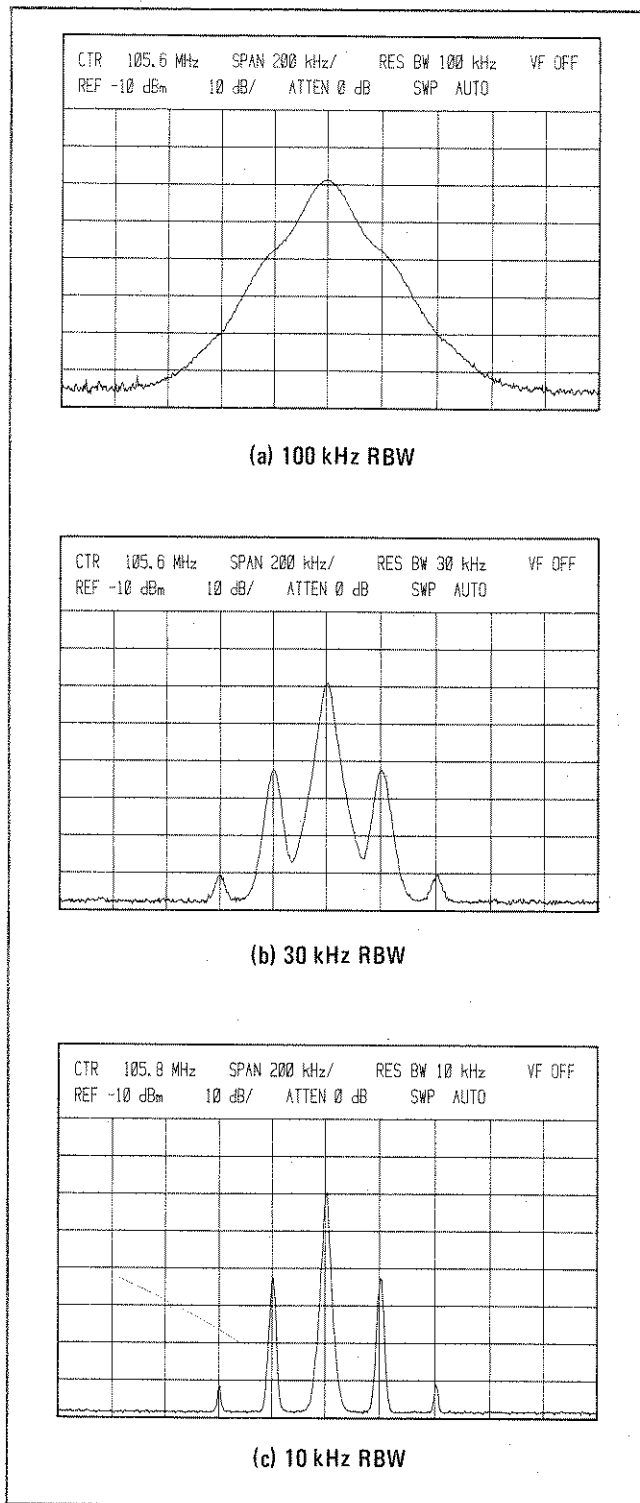

Figure 17. Resolving Modulation Sidebands

trol knob. This characteristic of the analyzer is used to improve the amplitude measurement accuracy using IF substitution (refer to Chapter 3).

The REFERENCE LEVEL control, combined with the INPUT ATTEN control, has a range of 172 dB; from

-112 dBm to +60 dBm, as shown in Figure 18a. Although the REFERENCE LEVEL control is calibrated from +30 dBm to +60 dBm, signal levels should never exceed +30 dBm since that is the maximum power the analyzer can withstand without damage. In Figure 18b, the REFERENCE LEVEL control was adjusted to position the peak of f_1 on the REFERENCE LEVEL line of the CRT. The absolute power of f_1 , then, is +30 dBm. The level at f_2 can be read from the calibrated CRT display as -20 dBm; that is, 50 dB below +30 dBm, assuming a 10 dB/Div Amplitude Scale factor. The Amplitude Scale factor can be set for 10 dB, 5 dB, 2 dB or 1 dB per division with respect to the REFERENCE LEVEL (top graticule line). The LIN scale factor sets the vertical calibration to volts with the bottom graticule line representing 0V. If desired, a low-level signal can be positioned at the REFERENCE LEVEL line to read its power level directly on the CRT annotation. The signal f_3 in Figure 18c is positioned on the REFERENCE LEVEL line to read -80 dBm directly.

The REFERENCE LEVEL line on the CRT is determined by a combination of IF gain (REFERENCE LEVEL control) and RF attenuation (INPUT ATTEN). The outer control knob adjusts the IF gain in 10 dB steps. A fine vernier knob provides continuous control from 0 to -12 dB.

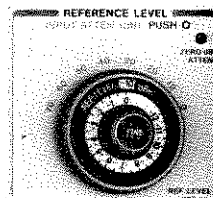

Pushing in the outer knob allows selection of RF input attenuation (blue numbers) from 0 to 70 dB. A reminder light is lit whenever 0 dB INPUT ATTEN is selected. Except for noise measurements or when maximum sensitivity is required, a minimum INPUT

ATTEN setting of 10 dB should always be used to ensure a good SWR and to minimize uncertainties due to mismatches.

HP-IB Code:

- RL (output REFERENCE LEVEL)
- LG (output AMPLITUDE SCALE)
- AT (output RF INPUT ATTENUation)

Video Filter



The VIDEO FILTER control is useful for observation of a low-level signal that is close to the noise level. Figure 19 illustrates how use of the VIDEO FILTER

control enables a low-level signal, close to the noise level, to be seen more clearly.

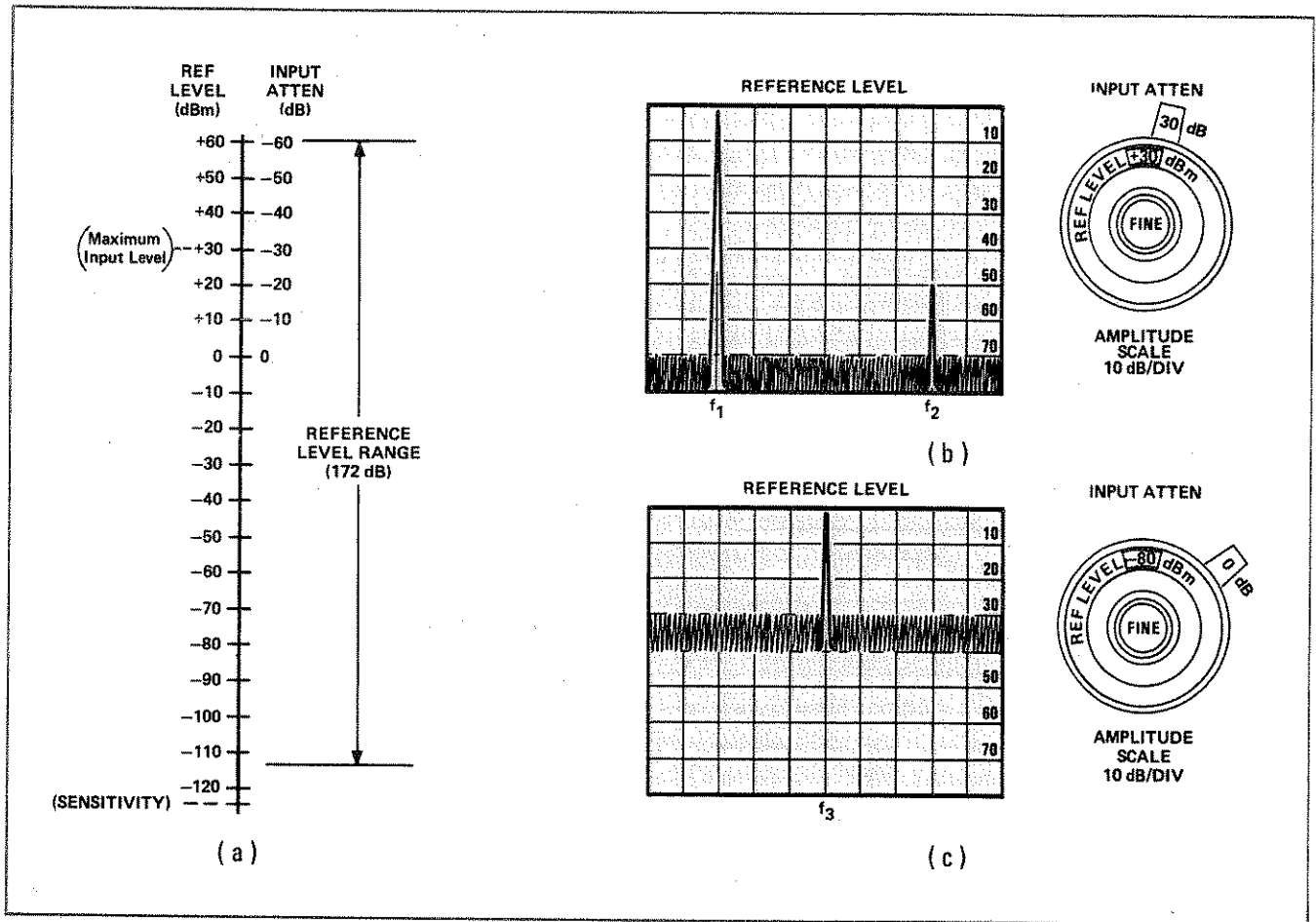

Figure 18. Reference Level

A NOISE AVG position on the VIDEO FILTER control allows the analyzer to perform noise level measurements or to measure its own sensitivity (for a

given RESOLUTION BW setting). The NOISE AVG position engages a 1 Hz low-pass filter to average the noise displayed on the CRT and the sweep time of the

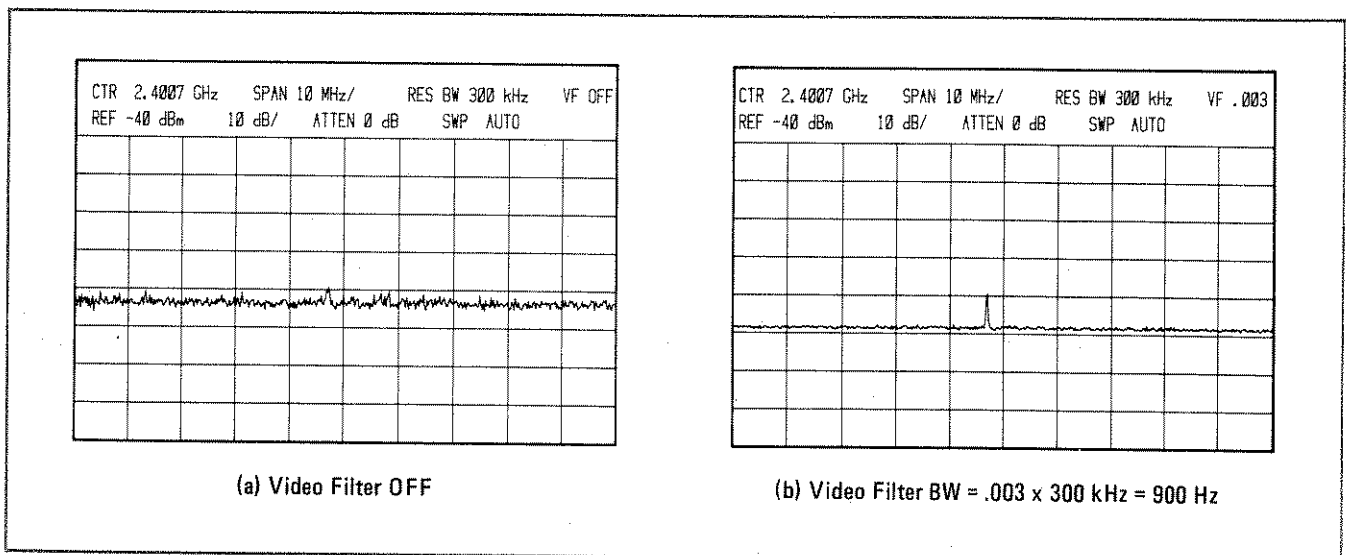

Figure 19. Video Filtering

analyzer is increased to facilitate noise level measurements.³ Another method of making noise and low-level signal measurements easily and accurately is to use DGTL
AVG (Digital Averaging) mode.

HP-IB Code:

VF (output VIDEO FILTER)

Sweep Time

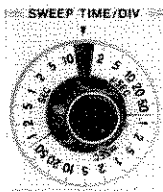

When SWEEP TIME/DIV is set to AUTO, the sweep time is automatically adjusted for all FREQUENCY SPAN/DIV, RESOLUTION BW, and VIDEO FILTER settings to maintain a calibrated amplitude display. The effect of the AUTO SWEEP

TIME/DIV setting may be observed by decreasing the VIDEO FILTER bandwidth setting. The sweep rate slows automatically to allow the narrow Video Filter bandwidths more time to respond. Calibrated sweep times from 2 μ sec/Div to 10 sec/Div are available when the SWEEP TIME/DIV control is not in AUTO. The faster sweep times (2 μ sec/Div to 1 msec/Div) are used only to display fast signal variations in the time domain (ZERO SPAN selected). At sweep speeds of 2 msec/Div and faster, a mixed mode is enabled in which the display characters and the illumination for the graticule remain digitally controlled while the displayed trace information is analog. At a sweep speed of 5 msec/Div, a mixed mode is enabled if the DGTL
AVG, INP-B
→ A, or MAX
HOLD pushbutton is pressed. When the mixed mode is enabled, the trace information cannot be transferred digitally.

When the SWEEP TIME/DIV control is operated manually (not in AUTO) or in any full-band mode, care must be taken to ensure that amplitude calibration is maintained. An uncalibrated display can easily be verified by the presence of the UNCAL readout in the CRT annotation. The SWEEP TIME/DIV control (AUTO or manual operation) will operate with any SWEEP TRIGGER setting as long as INT SWEEP SOURCE is selected.

³Because of detector and log amplifier characteristics, 2.5 dB should be added to obtain the correct noise power reading. Refer to Hewlett-Packard Application Notes 150-4 and 150-9 for details.

HP-IB Code:

ST (output SWEEP TIME/DIV or AUTO flag)
TS (take sweep)
SF (start sweep and set sweep flag)
MS (output value of sweep flag)

DIGITAL STORAGE DISPLAY

The spectrum analyzer CRT displays the signal response trace and all pertinent measurement data. The display information, provided at a flicker-free rate, can be stored for later reference. Certain arithmetic and signal processing functions such as MAX HOLD and Digital Averaging can be performed on the trace values.

The analyzer can output character information (Figure 20), or messages can be sent to the display via HP-IB.

HP-IB Code:

LU,LL (input lower, upper line messages)
AU,AL (display lower, upper line control settings)
CS (output annotation)

TRACES

Two independent traces (A and B) may be stored and then displayed either separately or simultaneously.

Error Detection

UNCAL: Uncalibrated display. Gives indication of incompatible FREQUENCY SPAN, RESOLUTION BW, VIDEO FILTER or SWEEP TIME/DIV settings when SWEEP TIME/DIV is not set to AUTO.

*: Invalid trace asterisk indicates that the displayed trace data has not been updated to reflect changes in control settings.

Display Error Messages: Provide feedback of incorrect control settings for the current measurement. (Display Error Messages are discussed later in this chapter.)

Clear/Reset

CLEAR/RESET clears trace data from the CRT and resets sweep when the instrument is in a write mode. In MAX
HOLD and DGTL
AVG modes, the processed trace is cleared and the sequence restarted. If a plot is in progress, it is aborted. During HP-IB operation, CLEAR/RESET halts HP-IB communication and returns the display to front-panel control.

Trace Modes

Four mutually exclusive modes for Trace A and Trace B determine the manner in which the traces of the input signals are displayed.

Write Modes. There are two write modes, in which the trace is updated, for Trace A and Trace B:

- WRITE displays the input signal response.
- MAX HOLD displays and holds the maximum responses of the input signal.

Store Modes. There are two store modes, in which the trace remains unchanged, for Trace A and Trace B:

- STORE VIEW stores the current trace and displays it on the CRT.
- STORE BLANK stores the current trace and blanks it from the CRT display.

When both Trace A and Trace B are in STORE BLANK, a single analog trace is displayed.

HP-IB Code:

TA,TB (output Trace A, Trace B integer values)
 BA,BB (output Trace A, Trace B byte values)
 AP,BP (output Trace A, Trace B peak signal coordinates)
 IA,IB (input Trace A, Trace B integer values)

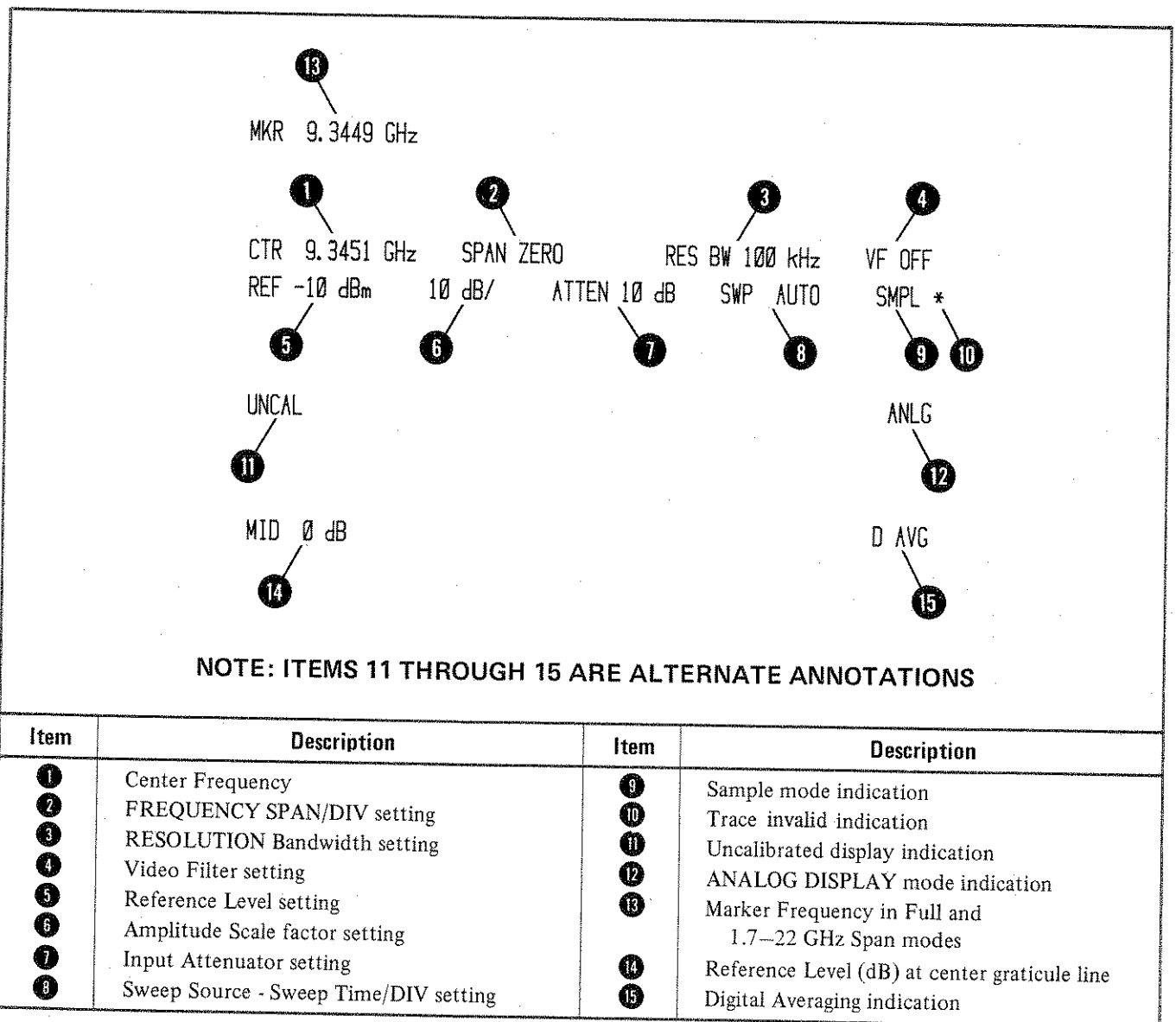

Figure 20. CRT Annotation

TRACE MEMORY

An understanding of the trace modes requires a description of trace memory and trace data transfer within the analyzer.

Display traces are not written directly to the CRT using the IF section video output (Figure 21). Instead, the video response is converted to digital information and stored in a trace memory which can then be transferred to the CRT display. The way in which the information is displayed depends upon the trace mode selected.

NOTE

It is important to understand the difference between 'sweep' and 'refresh.'

In 'sweep,' the spectrum analyzer sweeps across a frequency span and stores measured amplitude data in a trace memory.

In 'refresh,' display memory data is transferred to the CRT.

The video response is transferred into the trace memory at the sweep rate of the analyzer (selected sweep time). The trace memory is written to the CRT display at a refresh rate of about 55 Hz. This is rapid enough to prevent flickering of the trace on the CRT. Thus, trace intensities remain constant as analyzer sweep times are changed.

For write modes, the analyzer signal response is written into trace memory during the sweep, and the memory

contents are displayed on the CRT. In store modes, the trace memory is not updated. The current memory data is saved and is either displayed STORE VIEW or blanked STORE BLANK.

Signal Processing

One of two detection techniques can be selected for displaying trace information: Normal or Sample (Table 4).

Table 4. Detection Techniques

Mode	Access	Use
Normal	Default Mode Always selected if not in sample mode or in analog display	Most measurements when peak amplitude of response is desired
Sample	<input type="checkbox"/> SAMPLE pushed in	Random Noise Level measurements Digital Averaging (automatically selected) Zero Frequency Spans for sweep times ≥ 2 msec/DIV for most time domain analysis

During a sweep, only a specified amount of time is available for writing data into each of the 481 trace memory addresses. In each one of these time periods, the positive peak detector obtains the maximum video signal excursions and stores this value into the trace memory address. In the sample mode (SAMPLE),

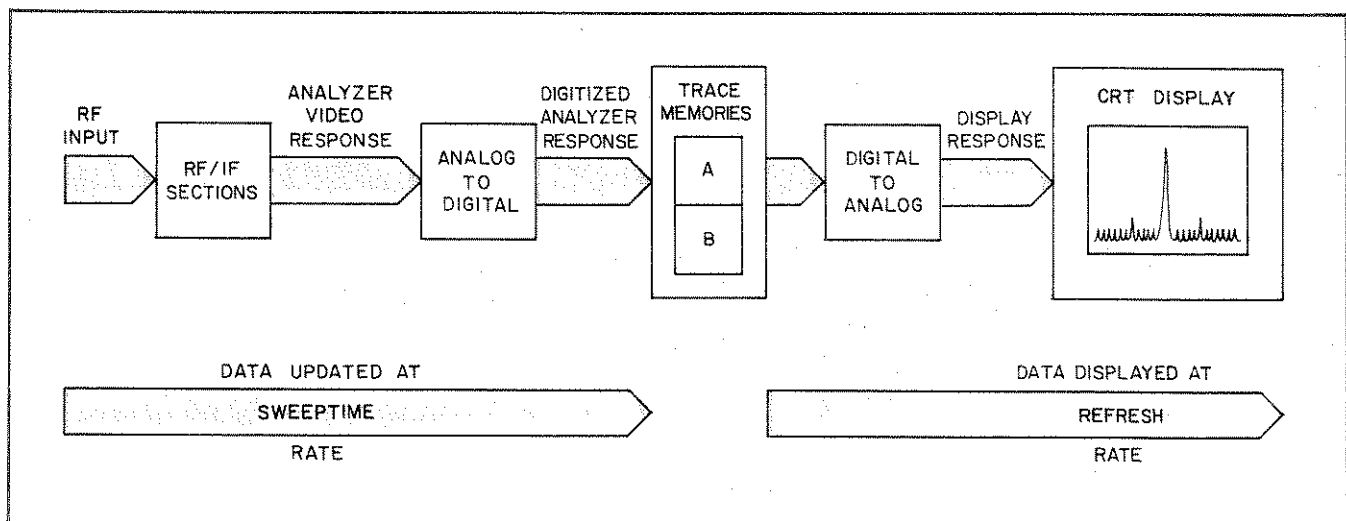

Figure 21. Data Acquisition and Transfer

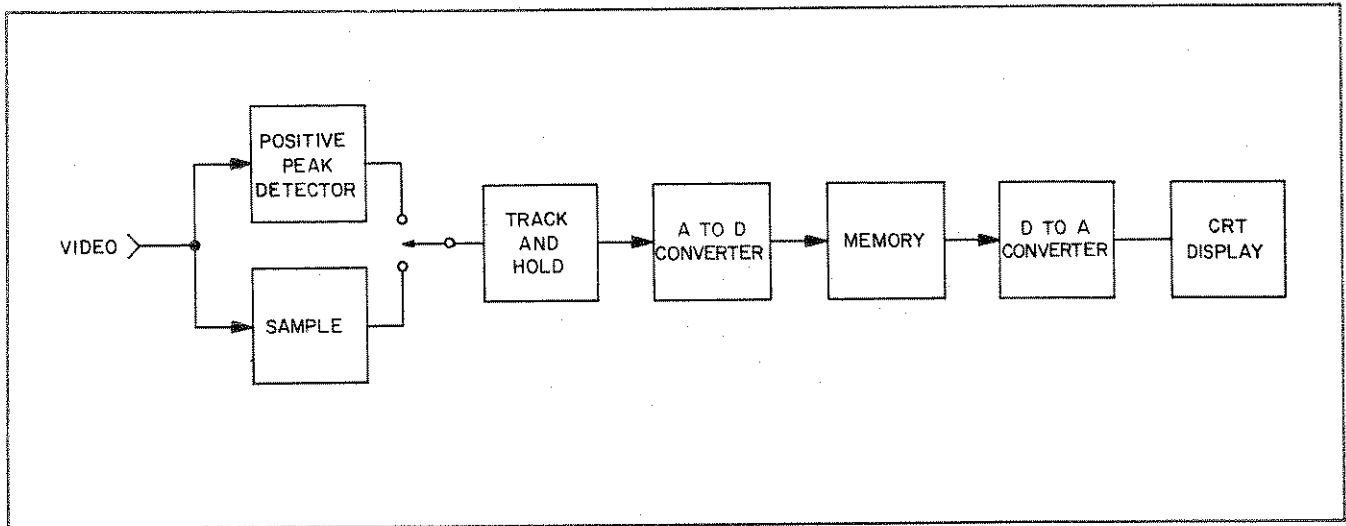

Figure 22. Detection Signal Flow

the instantaneous signal value of the final analog-to-digital conversion for the time period is placed in memory (Figure 22).

In Figures 23 and 24, the same signal response is displayed with each trace detection mode.

HP-IB Code:

DM (output SAMPLE state)

Digital Averaging

^{DGTL}AVG is a trace display routine that averages trace responses from sweep to sweep, thus averaging random noise without requiring a narrow video bandwidth. Maximum averaging is achieved after 64 sweeps. Both digital averaging and reduced video bandwidth are primarily used to improve the ability of the analyzer to

measure low level signals by smoothing the noise response.

The advantage of digital averaging over narrowing the video filter is the ability for the user to view changes made to the amplitude or frequency scaling of the display while smoothing the noise response. For example, to display very low level signal responses, very narrow resolution and video bandwidths are required. The accompanying increase in sweep time can make measurements cumbersome. Digital averaging allows the display of low level signals without long sweep times. (Any change to control settings will cause the digital averaging process to be restarted.)

Display Error Message ^{MAX}HOLD If either Trace A or Trace B is in the HOLD mode, an error message is displayed on the upper portion of the CRT.

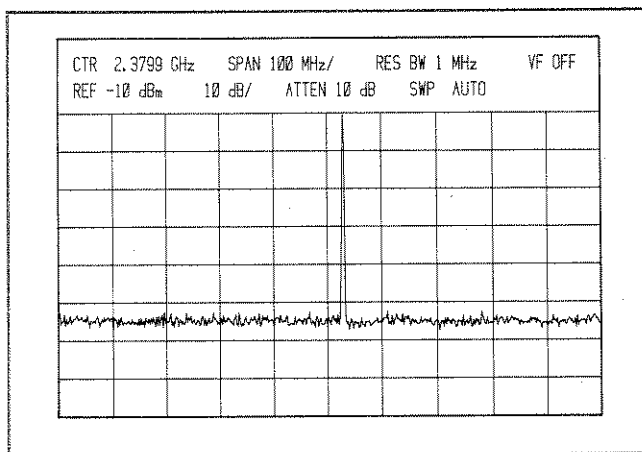

Figure 23. Normal Detection Mode

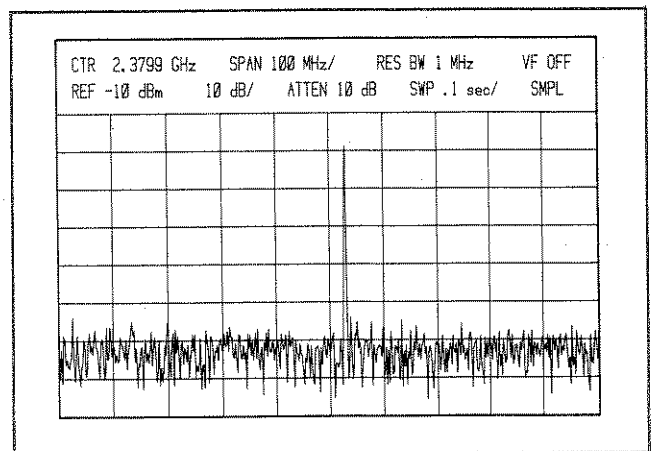

Figure 24. Sample Detection Mode

Digital Averaging Algorithm

The average of each amplitude point depends on the number of samples already taken and the last amplitude average. The exponentially weighted algorithm is expressed

$$Y_N = Y_{N-1} + \frac{S_N - Y_{N-1}}{F}$$

where Y_N = the latest measurement average

Y_{N-1} = the previous measurement average

S_N = the current measurement

N = sweep number

F = $2^{\text{INT}(1+\text{LOG}_2(N))}$

In other words, the difference between the previous average and the current measurement is divided by F . The result is then added to the previous average to obtain the new average.

For each sweep when $n > 64$, F (now 64) remains constant, and all new data is weighted by $1/64$ and added to the average amplitude after the most recent measurement. Therefore, the average follows only a slowly changing signal response.

HP-IB Code:

DG (output DGTL AVG state)

Trace Arithmetic

Trace arithmetic can be used either for comparison of two traces or for normalization in swept frequency measurements.

INP-B
- A

Trace B amplitude (measured in divisions from the bottom graticule) is subtracted from the input trace (Trace A); and the result is written into Trace A from sweep to sweep. Trace B must be in one of the STORE modes.

Display
Error
Message

If Trace B is not in STORE VIEW or STORE BLANK, an error message is displayed in the upper portion of the CRT.

Trace arithmetic can be used to correct for the frequency response characteristics (flatness) of a swept measurement system. (Refer to Chapter 3 for more detail.)

HP-IB Code:

NS (output INP - B → A state)

DIRECT PLOTTER OUTPUT

Graticule GRAT, character CHAR, and trace TRACE information can be output directly to a digital plotter through an HP-IB cable, without the need for a controller.

NOTE

If an HP-IB controller is connected to the HP-IB output of the HP 8569A, place controller in reset state (terminate any running program) before the direct plot routine is executed.

Digital plotters can provide full-size copies – up to 11 by 16 inches (approximately 279 by 406 mm) with the HP 9872B – that are ideal for lab reports and that can be reproduced more easily than photographs.

The HP 7225A and HP 9872B are among the plotters that are directly compatible with the HP 8569A. (Most of the CRT illustrations in this manual were directly plotted with the HP 7225A.)

To generate a plot:

1. Attach HP-IB cable from the HP-IB connector on the rear panel of the HP 8569A to the plotter rear panel HP-IB Connector as shown in Figure 25.
2. Establish the lower-left and upper-right limits on the plotter.
3. Press and release GRAT to plot graticule, CHAR to plot characters, and TRACE to plot trace data. (The plots may be run individually, or all three pushbuttons may be pressed immediately to run a complete plot of the total CRT display.)

To stop the direct plot routine, depress CLEAR/RESET.

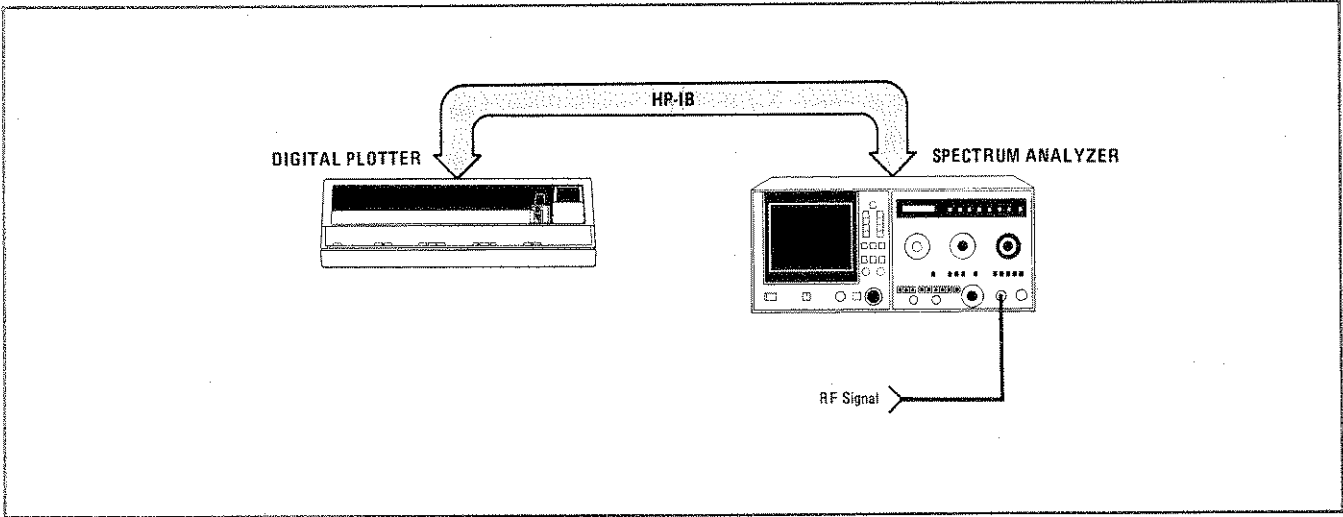

Figure 25. Digital Plotter Setup

CHAPTER 3 SPECIAL TOPICS

MAXIMUM DYNAMIC RANGE

Dynamic range is defined as the ratio of the largest to the smallest signal that can be measured without any interference from the analyzer distortion products or internal noise. The maximum dynamic range occurs when the internally generated distortion of the analyzer is equal to its noise level (Thus, the dynamic range is limited equally by both.)

Mixer distortion, caused by a large signal at the mixer, changes non-linearly as the fundamental signal amplitude is changed. That is, for example, a 10 dB change in amplitude causes a 20 dB change in second-order distortion level and a 30 dB change in third-order distortion. Therefore, the objective of the following discussion is to show that maximum dynamic range can be achieved by the judicious use of RF attenuation.

The maximum dynamic range of the HP 8569A can be determined by referring to Figure 28. Three types of curves are presented on the chart: sensitivity (solid line), second-order distortion (large dashed line), and third-order distortion (small dashed line). The sensitivity curves for the six internal frequency bands (0.01–22 GHz) are given for a 100 Hz bandwidth. To use the sensitivity curves for other resolution bandwidths, simply subtract 10 dB from the signal to noise reading for an increase in resolution bandwidth by a factor of 10. For example, a signal to noise ratio of 70 dB for a 100 Hz bandwidth would be 60 dB for a 1 kHz bandwidth. The second- and third-order distortion curves are dependent on whether the 0.01 to 1.8 GHz band or one of the preselected internal mixing bands is used. When more than one signal is at the RF input to the mixer, the distortion curves are also dependent on signal separation. Two vertical axes are used in Figure 28: Signal to Noise Ratio (right side) and Spurious-Free Dynamic Range (left side). The maximum dynamic range occurs at the intersection of the particular sensitivity curve and distortion curve under consideration. This point is obtained on the spectrum analyzer by adjusting the RF input attenuation to achieve the appropriate signal amplitude at the mixer.

Two major factors determine the maximum achievable dynamic range of the HP 8569A. They are:

1. Signal level at the Input Mixer.

2. Sensitivity of the analyzer (dependent on frequency band and resolution bandwidth).

These two factors are examined separately in the following paragraphs.

Mixer Level

The Mixer Level is simply the signal at the input minus the analyzer INPUT ATTEN setting. In equation form:

$$\text{Mixer Level} = \text{signal input} - \text{INPUT ATTEN}$$

The horizontal axis on the dynamic range chart represents the Mixer Level.

Dynamic range varies as a function of Mixer Level. In the 0.01 to 1.8 GHz range, the Mixer Level (for maximum dynamic range) should be approximately -45 dBm when second-order distortion products are measured. Beyond this level, second-order distortion will increase 20 dB for every 10 dB increase in signal input. For third-order distortion measurements, the Mixer Level should be approximately -37 dBm. In the preselected 1.7 to 22 GHz frequency range, dynamic range variation as a function of Mixer Level is not as critical. The maximum dynamic range in the preselected bands is achieved at a Mixer Level of approximately -7 dBm, which is the 1 dB gain compression level of the spectrum analyzer. This applies for both second- and third-order distortion products.

Example (see Figure 28).

It is desired to measure the third-order distortion products of a device. The input signals are at 1146 MHz and 1156 MHz and have an amplitude of -10 dBm. Find the Mixer Level to obtain the maximum dynamic range.

Solution:

The Mixer Level to achieve the maximum dynamic range is approximately -37 dBm (about -40 dBm for each signal). Since this is a third-order measurement, use the small dashed third-order distortion curve applicable to the frequency range. Intersect this curve with the sensitivity curve that covers 0.01 to 1.8 GHz. The maximum dynamic range for a 100 Hz resolution band-

width occurs at the intersection of the curves. The INPUT ATTEN control must therefore be set at 30 dB to achieve this dynamic range (see Figure 28a).

Sensitivity

Spectrum analyzer sensitivity has been traditionally defined as the average noise level displayed on the analyzer. The average noise level of the HP 8569A is dependent on the resolution bandwidth and on the FREQUENCY BAND selected. Since the noise displayed on the analyzer is random, it is dependent on bandwidth; therefore, for every decade increase (decrease) in resolution bandwidth the average noise level increases (decreases) by 10 dB.

The HP 8569A uses harmonic mixing (harmonics of local oscillator), to achieve 22 GHz (internal mixing) and 40 GHz (external mixing) frequency ranges. A characteristic of harmonic mixing is that the higher the harmonic mixing mode (corresponding to higher frequency bands) the higher the noise level of the analyzer (i.e., sensitivity decreases). Therefore, the best sensitivities are achieved on the lower frequency bands. Figure 28c shows analyzer sensitivity for a 100 Hz resolution bandwidth for the six different frequency bands.

Preselection.

Another factor to consider in determining maximum dynamic range, besides mixer level and sensitivity, is

preselection. In comparing the distortion curves for the 1.7 to 22 GHz frequency range to the 0.01 to 1.8 GHz frequency range in Figure 28c, it can be seen that the dynamic range for the preselected band (1.7 to 22 GHz) is generally much greater when the signal separation is ≥ 100 MHz. This benefit is due to the tracking preselector, a tunable bandpass filter that tracks the tuning of the analyzer. The preselector extends the dynamic range of the analyzer to measure a low level signal in the presence of a potentially interfering high level signal. Since the preselector tracks the tuning of the analyzer, it allows a signal to pass to the mixer when both preselector and analyzer are tuned to receive it. When the analyzer is tuned to the low-level harmonic, the preselector rejects the high-level fundamental, thus preventing internal distortion products from affecting the measurement. This condition is illustrated in Figure 26.

In the preselected frequency bands (1.7 to 22 GHz) the tracking bandpass filter has a nominal 50 MHz bandwidth and a worst case rejection of >60 dB (60 dB – 18 to 22 GHz, 70 dB – 1.7 to 18 GHz). For signal separation ≥ 100 MHz, the tracking filter will allow only one signal to pass to the mixer while simultaneously rejecting the other signal. This is illustrated in Figure 27. Since only one signal is seen at the mixer at any instant of time, the third-order distortion products of the analyzer are significantly reduced. Also, for larger

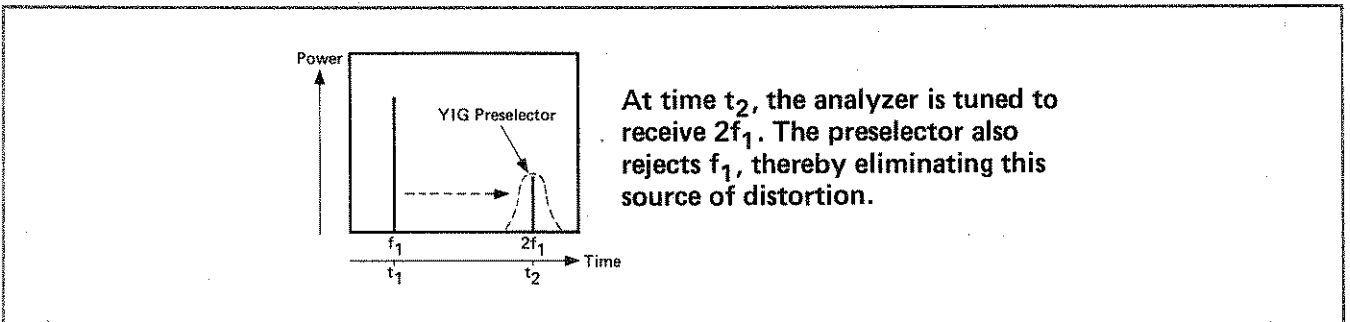

Figure 26. YIG Preselector Tuning

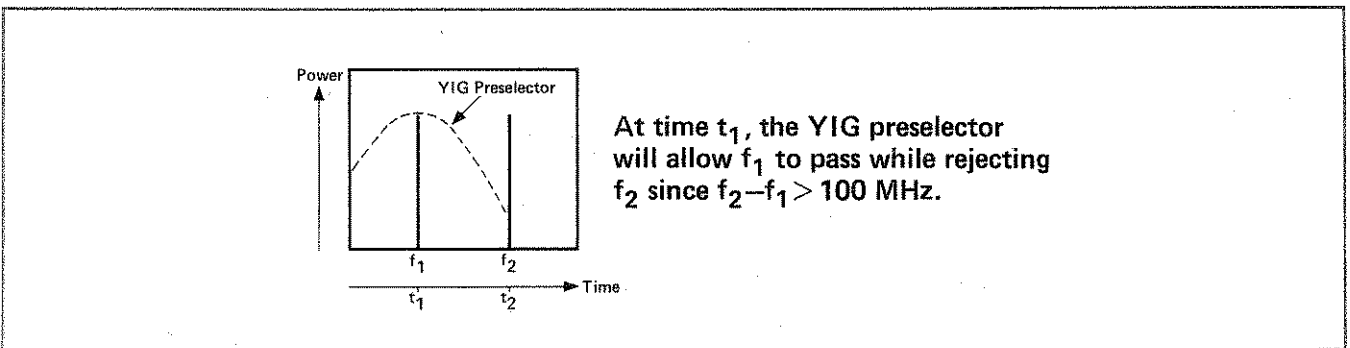

Figure 27. YIG Preselector Passband

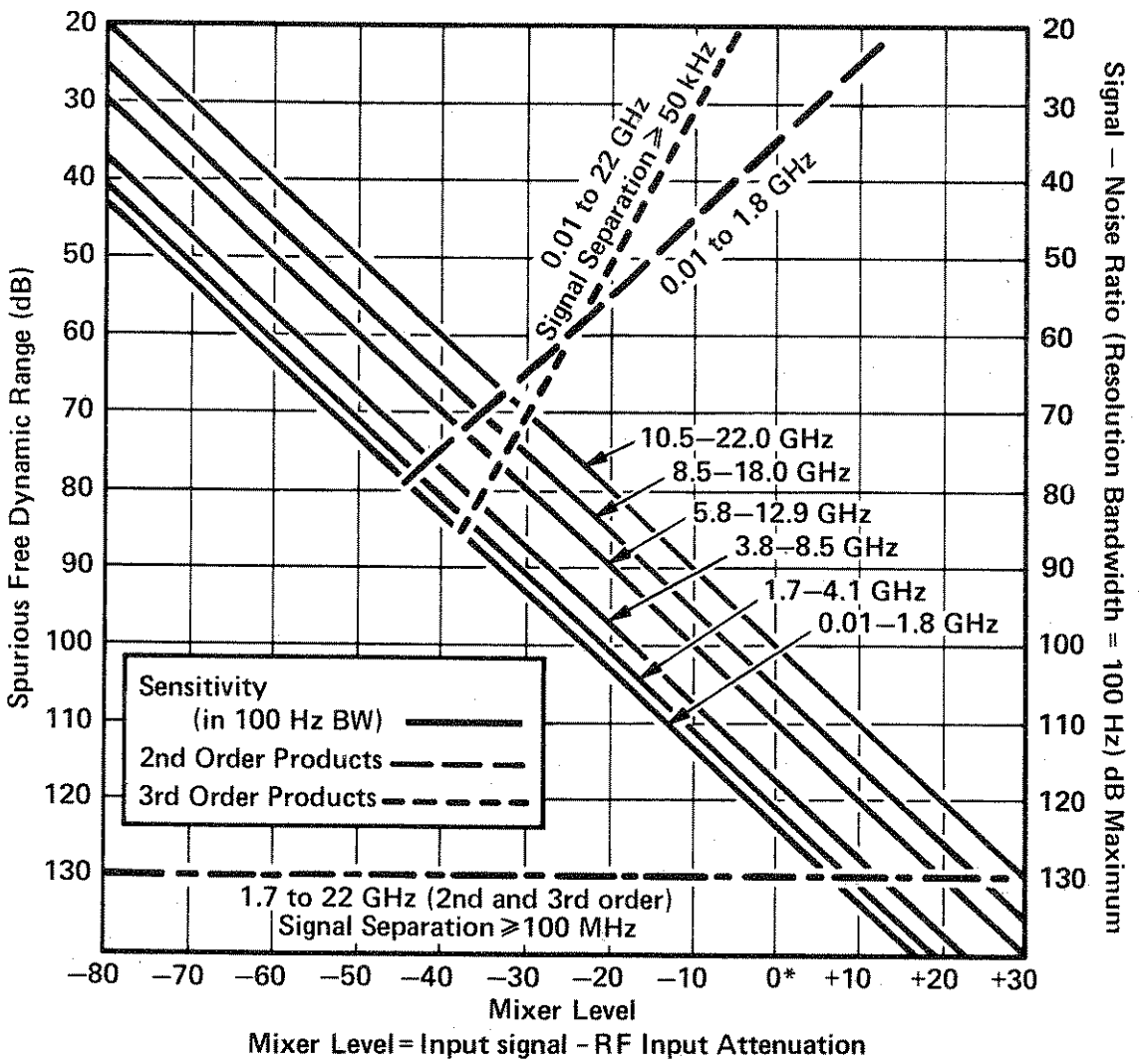
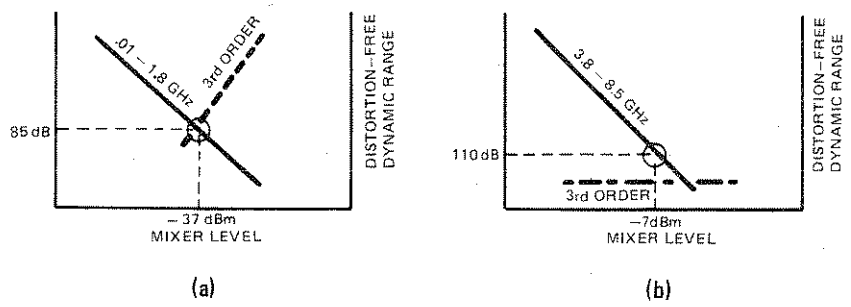

Figure 28. Dynamic Range

signal separation, the preselector has more rejection and hence the dynamic range is greater.

The distortion curves for the 1.7–22 GHz frequency range are represented by a horizontal line. The line represents both the second- and third-order distortion curves, which theoretically have the same slope as the distortion curves in the non-preselected modes. However, the curves are represented as a horizontal line because the absolute levels of the internally generated distortion are generally well below the internally generated noise of the analyzer.

Example:

It is desired to measure the third-order intermodulation products of a microwave amplifier. The two output signals are –10 dBm at 5.9 and 6.1 GHz. What is the maximum dynamic range of the analyzer?

Solution:

The maximum dynamic range is approximately 110 dB. Note that the signal separation is 200 MHz; therefore, the second- and third-order distortion of the analyzer is represented by the distortion curve for the preselected band (1.7 to 22 GHz with signal separation ≥100 MHz). For a mixer input level of –7 dBm (–10 dBm for each signal) the distortion curve is below the sensitivity curve of the analyzer; therefore, the dynamic range is determined by the intersection of the 3.8–8.5 GHz sensitivity curve with the –7 dBm mixer level. The dynamic range of the analyzer is approximately 110 dB (see Figure 28b).

Other constraints: When measuring distortion products associated with low-level signal inputs, the noise floor of the analyzer is the limitation. In this case, find the signal level on the Mixer Level (horizontal) axis and go vertically to the appropriate sensitivity curve. The maximum obtainable dynamic range is read from the signal to noise ratio (vertical) axis.

Dynamic Range Equations

The dynamic range curve shown in Figure 28 is based on the following equations for third- and second-order maximum dynamic range.

For third-order = $2/3(\text{average noise level} - \text{TOI})$ in dB

For second-order = $1/2(\text{average noise level} - \text{SOI})$ in dB

The third-order intercept (TOI) is theoretically defined as the mixer level at which third-order distortion equals the fundamental signal level (a condition which never

occurs because compression in the mixer occurs first). The second-order intercept (SOI) is theoretically defined as the mixer level at which second-order distortion equals the fundamental signal level. The intercept is calculated from the following equation:

$$\text{Intercept} = \text{mixer level} - \frac{(\text{distortion (dBc)})}{N - 1}$$

where N = order of distortion

These equations are used to compute the best dynamic range for either third- or second-order distortion products and noise. The noise level is the displayed noise level for the resolution bandwidth and center frequency to be used, assuming 0 dB input attenuation.

Example: In measuring a 10.50 GHz signal and a 10.55 GHz signal in a 1 kHz resolution bandwidth, the typical sensitivity of the analyzer is –100 dBm, assuming 0 dB input attenuation. The HP 8569A has a TOI of +5 dBm and SOI of +35 dBm for signal separations of <100 MHz. What is the maximum dynamic range?

Solution:

70 dB for third-order and approximately 67 dB for second-order.

$$\begin{aligned} \text{Third-order} &= \left| \frac{2}{3}(-100 \text{ dBm} - +5 \text{ dBm}) \right| \\ &= 70 \text{ dB} \end{aligned}$$

$$\begin{aligned} \text{Second-order} &= \left| \frac{1}{2}(-100 \text{ dBm} - +35 \text{ dBm}) \right| \\ &= 67.5 \text{ dB} \end{aligned}$$

It is also possible to determine the value of total RF attenuation (internal or external) needed to obtain the maximum dynamic range for a given input power level from the following equations.

For third-order:

$$\text{Atten} = \text{Input} - 2/3 \text{ TOI} - 1/3 \text{ Noise Level}$$

For second-order:

$$\text{Atten} = \text{Input} - 1/2 \text{ SOI} - 1/2 \text{ Noise Level}$$

For the same conditions as in the previous example, with an input signal of –20 dBm, the RF attenuation should be set to:

Third-order:

$$\begin{aligned} \text{Atten} &= -20 \text{ dBm} - 2/3(+5 \text{ dBm}) - 1/3(-100 \text{ dBm}) \\ &= 10 \text{ dB} \end{aligned}$$

Second-order:

$$\begin{aligned} \text{Atten} &= -20 \text{ dBm} - 1/2(+35 \text{ dBm}) - 1/2(-100 \text{ dBm}) \\ &= 12.5 \text{ dB.} \end{aligned}$$

Therefore, RF attenuation must be set to 10 dB to maximize third-order and 12.5 dB to maximize second-order dynamic range.

IMPROVING AMPLITUDE MEASUREMENT ACCURACY

The technique known as IF substitution can be used to improve measurement accuracy on the HP 8569A. IF substitution is a method of using only the accurate IF gain of the analyzer to position the signal on the calibrated REFERENCE LEVEL line. In this way, errors due to CRT non-linearity, log amplifier, input attenuator, and bandwidth filter will be eliminated. The IF gain of the analyzer is controlled with the calibrated REFERENCE LEVEL dBm control.

Amplitude Measurement with IF Substitution

The steps for achieving accurate amplitude measurements with IF substitution are as follows:

1. Set the INPUT ATTEN control to 10 dB or greater. This ensures a good input SWR to minimize mismatch errors.
2. Set the FREQUENCY SPAN/DIV control to the desired frequency resolution.
3. Connect the CAL OUTPUT signal to the analyzer to verify calibration.
4. Disconnect the CAL OUTPUT signal and connect the signal to be measured.
5. Press the desired FREQUENCY BAND pushbutton and use only the TUNING control to center the signal on the CRT.
6. In the 1.7 to 22 GHz frequency range, adjust the PRESELECTOR PEAK control to maximize the signal level.⁴
7. Now, using only the REFERENCE LEVEL dBm control and vernier, position the peak of the signal

⁴The best broadband tracking performance of the pre-selector is normally obtained with the PRESELECTOR PEAK control centered in the green area. However, for accurate power measurement, the PRESELECTOR PEAK control should be adjusted to maximize signal level every time an amplitude measurement is made.

on the REFERENCE LEVEL line of the CRT. The signal amplitude is indicated by REF on the CRT annotation.

When the IF substitution technique is used for amplitude measurements, the only remaining measurement uncertainties are due to the CAL OUTPUT signal, flatness, and REFERENCE LEVEL control accuracy of the analyzer. Uncertainties due to log amplifier fidelity, CRT non-linearities, RESOLUTION BW and INPUT ATTEN switching errors have been eliminated because they were left unchanged throughout the measurement.

Further improvement in accuracy can be achieved by calibrating the analyzer at the same frequency to which the measurement will be made. This would eliminate any flatness uncertainties, and the measurement accuracy would be dependent only upon the accuracy of the calibration signal and the REFERENCE LEVEL control.

CRT PHOTOGRAPHY AND X-Y RECORDING

CRT Photography

The CRT annotation on the HP 8569A display provides an excellent means of information retention with the use of any compatible scope camera. Since the display has readouts for all major spectrum analyzer settings, the need for additional writing on the photograph is largely eliminated. Also, interference between trace and characters is not a problem because the character annotation is located on the upper portion of the display, outside the graticule (refer to Figure 29).

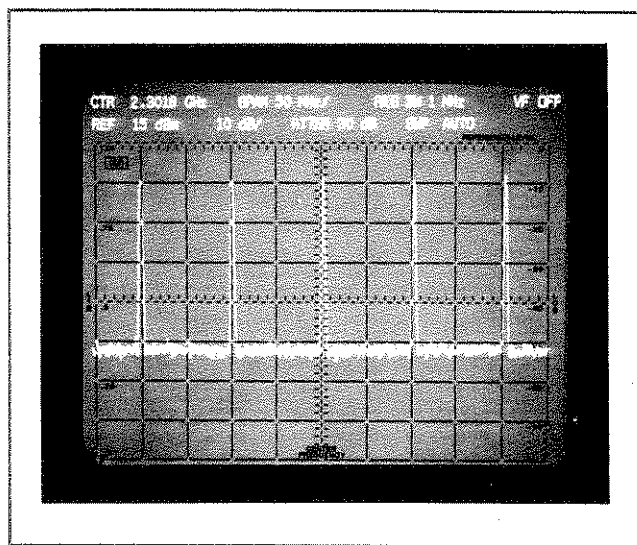

Figure 29. CRT Display with Character Annotation

The photo in Figure 29 was taken with a camera that has variable shutter speed and f-stop. A step-by-step pro-

cedure for photography is given below. These steps are applicable with the HP 197B Option 006 or other compatible scope cameras.

Photography Procedure

1. Set the HP 8569A SCALE INTEN and INTEN to the calibrated blue markings.
2. Set the camera shutter to 2 seconds and the f-stop to 8.
3. Push the STORE VIEW button on the analyzer to store the trace. This ensures the trace and the CRT frequency readout on the display will not change while the camera shutter is opened. Press shutter on camera to take picture.

In the mixed display mode (refer to Appendix B), a double exposure is needed to provide the best contrast between signal trace, graticule lines, and CRT annotation.

Double Exposure Photography

1. Set INTEN fully counter-clockwise.
2. Set SCALE INTEN to calibrated blue markings.
3. Set SWEEP TIME/DIV to AUTO.
4. Set shutter speed to ≥ 2 sec and f-stop to 8.
5. Press shutter on camera to take first exposure.
6. Return SWEEP TIME/DIV to original setting.
7. Set INTEN to the calibrated blue markings.
8. Press STORE VIEW .
9. Press shutter on camera to take second exposure.

To set up the initial focusing of the camera the user is referred to the Operation Section of the 197B Operation and Service Manual (HP Part Number 00197-90915).

Analog X-Y Recording

The HP 8569A is directly compatible with the HP line of X-Y recorders as well as strip-chart and magnetic tape recorders. The VERTICAL OUTPUT, BLANK OUTPUT, and HORIZONTAL SWEEP OUTPUT are available from the rear panel of the analyzer. As with digital plotters, X-Y recorders can provide full-size, high-resolution copies – up to 11 by 14 inches (approximately 279 to 356 mm) – that are more convenient than

photographs for laboratory report folders. Figure 30 illustrates a typical setup used for X-Y recording.

The bandwidth of most X-Y recorders is very narrow, typically 1 to 2 Hz. This narrow bandwidth requires a sweep rate that is slow enough for the recorder to fully respond to a signal. In general, a sweep rate of 2 sec div is sufficient for most X-Y recorders. The SINGLE or the MANUAL sweep mode on the HP 8569A can be used to control the sweep.

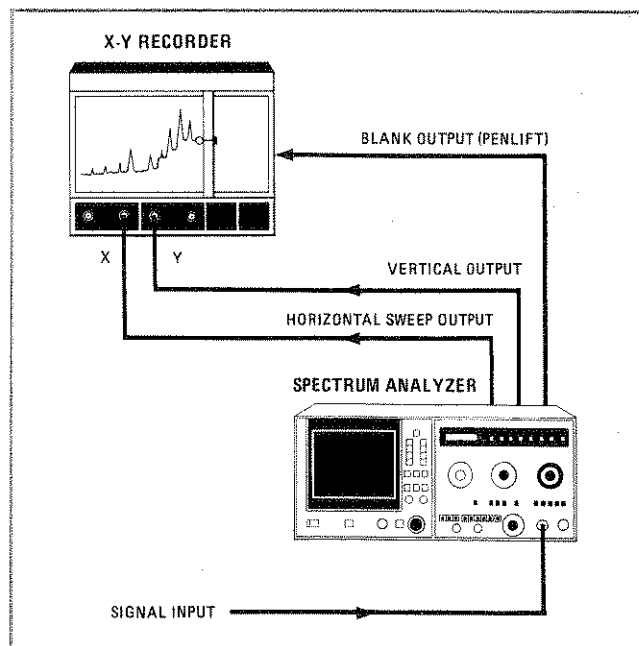

Figure 30. X-Y Recording

EXTERNAL MIXER OPERATION

Calibrated frequency coverage from 14.5 to 40 GHz can be achieved by using the 11517A Option E03 External Mixer. Coverage above 40 GHz can be accomplished with a variety of commercially available mixers documented in HP AN 150-14. The HP 11517A must be used with the appropriate waveguide adapter listed in Table 5. The external mixer connects to the EXT MIXER port on the front panel of the HP 8569A by means of a coaxial cable that has SMA male connectors. Selection of the corresponding FREQUENCY BAND will allow frequency coverage in two ranges: 14.5 to 26.6 GHz or 22.9 to 40 GHz.

A test setup of the HP 8569A with the HP 11517A External Mixer and adapter is illustrated in Figure 31.

The EXT MIXER port is unique in that three signals are present. The LO and bias current (I_{bias}) exit to the HP 11517A and the IF is received back at the EXT MIXER port. Filter networks at the EXT MIXER port separate the unwanted RF signals from the desired IF product.

The BIAS control is adjusted to optimize the signals viewed with the external mixer.

In operation, the HP 11517A External Mixer bypasses the input attenuator, preselector, and the calibrated internal mixer of the analyzer. Three things must be remembered when using the external mixer:

1. The INPUT ATTEN has no effect on input signals.

Table 5. External Mixer Components

HP Model Number	Description	HP Band Designation
11517A	12.4–40 GHz Mixer	
11518A	12.4–18 GHz Adapter	P
11519A	18–26.5 GHz Adapter	K
11520A	26.5–40 GHz Adapter	R

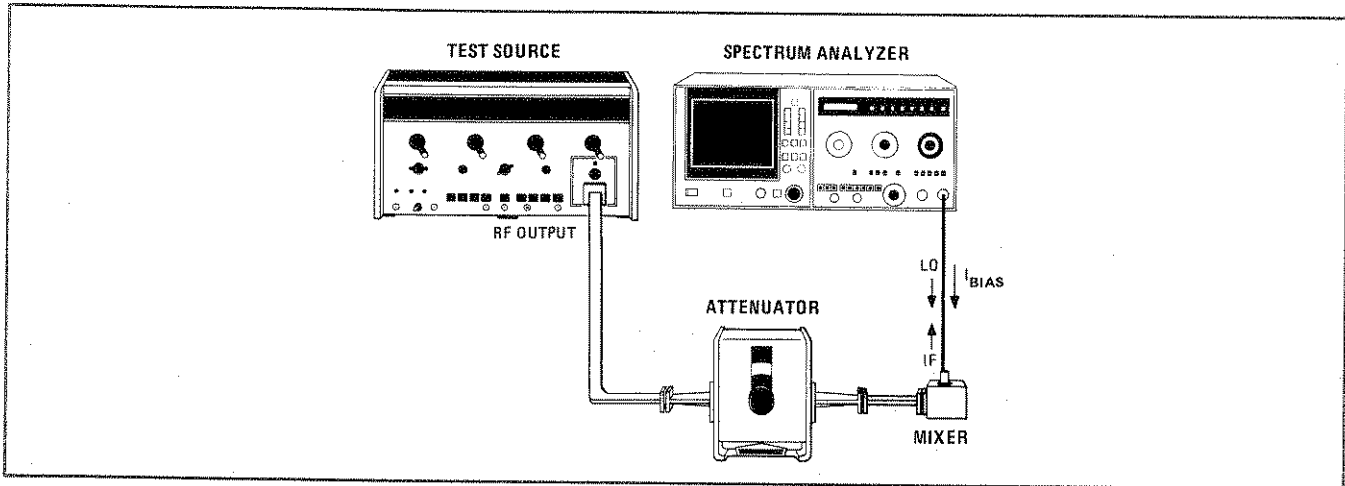

Figure 31. External Mixer Test Setup

2. Harmonic mixing responses must be properly identified since there is no preselection in the EXT MIXER bands. (Also, the PRESELECTOR PEAK control will not affect the display.)
3. Amplitude measurements are uncalibrated unless steps are taken to calibrate the analyzer.

signals; however, there is a displayed response on one or more of the frequency bands which will identify the signal correctly.

Signal Identification

To properly identify a signal on the CRT, the SIG IDENT pushbutton on the HP 8569A is used. To use the SIG IDENT, center the unknown response on the CRT. Then press the SIG IDENT pushbutton and note whether the response resembles that shown in Figure 32. If the response moves to the left 2 MHz and drops in amplitude, it is the correct signal and its frequency is indicated on the display. When a signal cannot be identified in any of the EXT MIXER frequency bands, one of two conditions applies:

1. The signal is not in the 14.5 to 40.0 GHz frequency range.
2. The displayed response is a product generated by a harmonic of the Local Oscillator not utilized by the analyzer in displaying amplitude calibrated

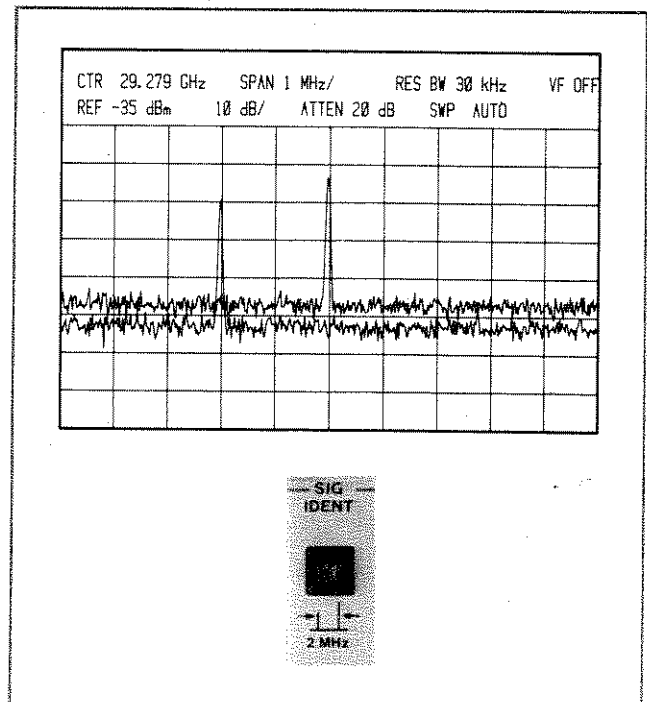

Figure 32. Signal Identifier

In either case the signal frequency can be approximated from the following equation:

$$F_S = NF_{LO} \pm F_{IF} \quad (1)$$

where F_S = input signal

N = mixing mode

F_{LO} = first local oscillator frequency

F_{IF} = first intermediate frequency

The first step in calculating the input frequency is to calculate the actual mixing mode (N_A) using the following equation.

$$N_A = \frac{2 \text{ MHz}}{\text{Signal Shift (MHz)}} \times N \text{ of frequency band selected} \quad (2)$$

where N = harmonic mixing mode

N_A = actual mixing mode

Signal Shift = signal shift on CRT in MHz with ON

The next step in the determination of F_S , the actual input signal, is to calculate the local oscillator fundamental frequency. Referring to equation (1), the LO fundamental frequency can be calculated from the value of F_S (obtained from CRT or LED center FREQUENCY GHz display), N (determined from the FREQUENCY BAND selected), and F_{IF} (first Intermediate frequency of the HP 8569A which equals 2.05 GHz). The '+' or '-' sign is determined by the polarity of the mixing mode on the Frequency Band selected.

For example,

$$\text{If } F_S = 34.5 \text{ GHz}$$

$$N = 10+$$

$$F_{IF} = 2.05 \text{ GHz}$$

From equation (1)

$$F_S = NF_{LO} \pm F_{IF}$$

$$34.5 \text{ GHz} = (10) \times F_{LO} + 2.05 \text{ GHz}$$

$$F_{LO} = 3.245 \text{ GHz}$$

The final step is to calculate F_S (the actual input signal) using equation (1), and the value of F_{LO} , N_A , and F_{IF} . The '+' or '-' sign in this final calculation is determined

by the direction of the signal shift. A shift to the left requires the '+' sign, while a shift to the right requires the '-' sign.

Example:

A signal displayed on the HP 8569A has a center FREQUENCY GHz readout of 38.00 GHz. When the SIG IDENT button is pressed, a second signal appears offset to the left by 4 MHz. What is the actual frequency of the signal?

Solution:

1. Calculate N_A using equation (2) while noting that 38.00 GHz is within the 22.9 to 40 GHz band, which has $N = 10+$.

$$N_A = \frac{2 \text{ MHz}}{4 \text{ MHz}} \times 10$$

$$N_A = 5$$

2. Calculate F_{LO} using equation (1) using

$$F_S = 38.00 \text{ GHz (center FREQUENCY GHz readout)}$$

$$N = 10 \text{ (corresponding to 22.9 to 40 GHz band)}$$

$$F_{IF} = 2.05 \text{ GHz (EXT MIXER 1st Intermediate frequency)}$$

Therefore,

$$38.00 \text{ GHz} = 10 \times F_{LO} + 2.05 \text{ GHz}$$

$$F_{LO} = 3.625 \text{ GHz}$$

NOTE

F_{LO} can also be obtained from Tuning Curves on Figure 61.

3. Calculate actual value for F_S . The signal shift was to the left; therefore, '+' sign is used.

$$\begin{aligned} F_S &= NF_{LO} + F_{IF} \\ &= 5 \times 3.625 \text{ GHz} + 2.05 \\ &= 20.175 \text{ GHz} \end{aligned}$$

In summary, this calculation is simply to verify that the observed signal is actually a mixing product of the 5, 7, 8 or 9 mixing modes, or that the signal is outside the 14.5 to 40 GHz frequency range.

Amplitude Calibration of External Mixer

The analyzer can be calibrated to read absolute power if a reference signal is available in the frequency range of interest (same harmonic mixing mode as the measurement signal). This is done by using both the INPUT ATTEN control and the REF LEVEL CAL adjustment on the analyzer. Since the INPUT ATTEN control is bypassed in EXT MIXER operation, it has no effect on the signal but will affect the REF level readout. Thus the INPUT ATTEN control provides a method of calibrating the analyzer to within ± 5 dB (attenuator has 10 dB steps) of the reference signal. To adjust between the ± 5 dB limit, use the REF LEVEL CAL adjustment to bring the display into an absolute power calibration. A step-by-step procedure for calibrating the analyzer to measure absolute power up to 40 GHz with the HP 11517A mixer is as follows:

1. Set up equipment as shown in Figure 31.
2. Connect reference signal to external mixer and select corresponding EXT MIXER frequency band to be calibrated. The variable attenuator ensures that the mixer power limitation is not exceeded. For the greatest accuracy, the reference signal's frequency should be as close as possible to anticipated signals to be measured. If signals are to be measured across the entire frequency band, the calibrated frequency should be near the middle of that band.
3. Press SIG IDENT pushbutton to verify that the response is the reference signal.
4. Peak the reference signal displayed on the analyzer with bias control. Adjust to maximum peak, since it is normal to see more than one peak.
5. Set the INPUT ATTEN control to 0 dB and the REF LEVEL FINE control to 0 dB.
6. Position the reference signal as close as possible to the REFERENCE LEVEL line using only the coarse REF LEVEL dBm control.
7. Since the amplitude of the reference signal is known, adjust the INPUT ATTEN to obtain the correct amplitude reading on the CRT display readout. If the reference signal is not in even 10 dB increments (e.g., -20 dBm, -30 dBm) adjust the REFERENCE LEVEL FINE control to obtain the correct REF LEVEL dBm display.
8. At this point, the REF LEVEL dBm display should read the amplitude of the reference signal. Also, the signal should be positioned within ± 5 dB of the REFERENCE LEVEL line. The final step is to position the reference signal on the REFERENCE LEVEL line by using the REF LEVEL CAL adjustment.

Once the reference signal is at the REFERENCE LEVEL line and the REF level reading equals the absolute value of the reference signal, the analyzer will be amplitude calibrated for that particular EXT MIXER band.

NOTE

If the REF LEVEL CAL adjustment was used to calibrate the EXT MIXER band, the analyzer must be recalibrated to its internal CAL OUTPUT signal for the internal mixing frequency range.

Additional information on external mixer measurements up to 40 GHz can be obtained from AN 150-12. Information on using external waveguide mixers above 40 GHz can be obtained from AN 150-14.

CHAPTER 4 TYPICAL MEASUREMENTS

DISTORTION

Distortion measurement is an area in which the spectrum analyzer makes a significant contribution. Two basic types of distortion are usually specified by the manufacturer: harmonic distortion and two-tone, third-order intermodulation distortion. The third-order intermodulation products are represented by: $2f_1 - f_2$ and $2f_2 - f_1$ where f_1 and f_2 are the two-tone input signals.

The HP 8569A is capable of making a wide variety of distortion measurements with speed and precision. The instrument can measure harmonic distortion products greater than 100 dB down in the 1.7 to 22 GHz frequency range. Third-order intermodulation products can also be measured greater than 100 dB down, depending on signal separation and frequency range.

Amplifiers

All amplifiers generate some distortion at the output, and these distortion products can be significant if the amplifier is overdriven with a high-level input signal. The test setup in Figure 33 was used to measure the third-order intermodulation products of a microwave field-effect transistor (FET) amplifier. Directional couplers and attenuators were used to provide isolation between sources.

Figure 34 is a CRT plot of a two-tone, third-order intermodulation measurement. The third-order products ($2f_1 - f_2$ and $2f_2 - f_1$) are below the two-tone signals (f_1 and f_2).

Mixers

Mixers use the non-linear characteristics of an active or passive device to achieve a desired frequency conversion. As a result some distortion at the output is due to the inherent non-linearity of the device. Figure 35 illustrates the test setup and CRT plot of a typical mixer measurement. Once the RF input and LO input signals were measured on the spectrum analyzer, from a single display, the following information was determined:

Conversion loss (SSB):

$$RF_{in} - IF = (-25) - (-34) = 9 \text{ dB}$$

LO to IF isolation:

$$LO_{in} - LO_{out(IF)} = (+5) - (-38) = 43 \text{ dB}$$

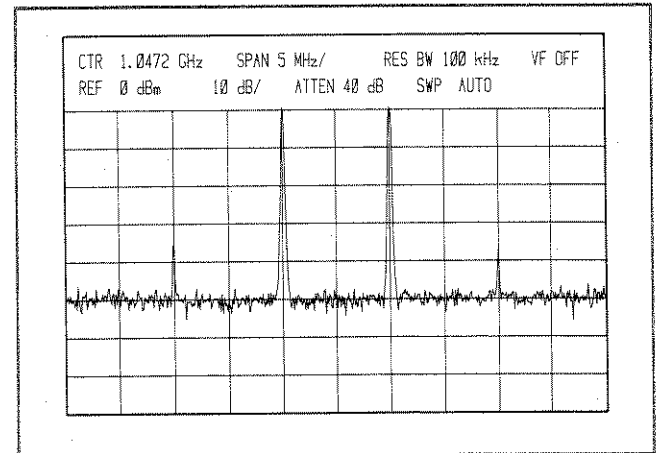

Figure 34. Two-Tone, Third Order Intermodulation Products

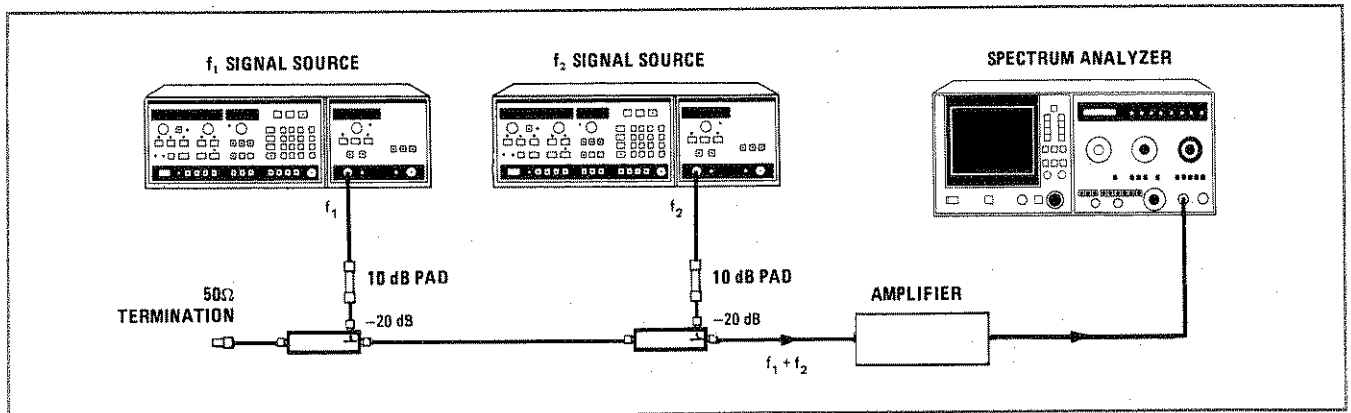

Figure 33. Two-Tone Test Setup

RF to IF isolation:

$$RF_{in} - RF_{out(IF)} = (-25) - (-54) = 29 \text{ dB}$$

Third-order distortion product (2 LO - RF):

$$-74 \text{ dBm at } 360 \text{ MHz.}$$

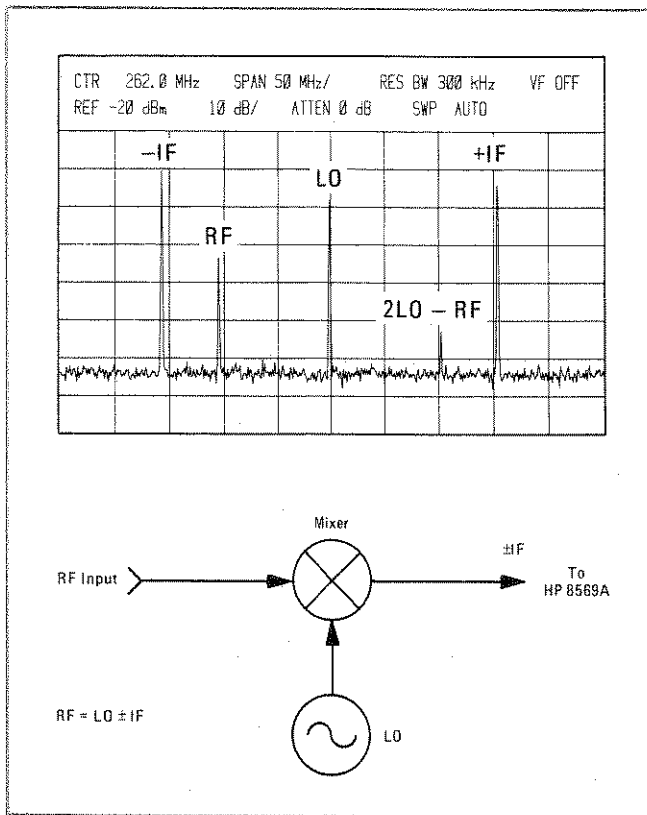

Figure 35. Mixer Measurement

Oscillators

Distortion in oscillators may be harmonically or non-harmonically related to the fundamental frequency. Non-harmonic oscillator outputs are usually termed spurious. Both harmonic and spurious outputs of an oscillator can be minimized with proper biasing and filtering techniques. The HP 8569A can monitor changes in distortion levels while modifications to the oscillator are made. In the full-band modes, a tuning marker can be located under any signal response to determine its frequency and hence its relationship to the fundamental frequency of the oscillator. Figure 36 is a CRT plot of the fundamental and second harmonic of an S-band (2 to 4 GHz) YIG oscillator. The internal preselector of the HP 8569A enables the analyzer to measure a low-level harmonic in the presence of a high-level fundamental. The plot was obtained using the MAX HOLD capability of the analyzer to allow storage of the maximum deviations of the signals.

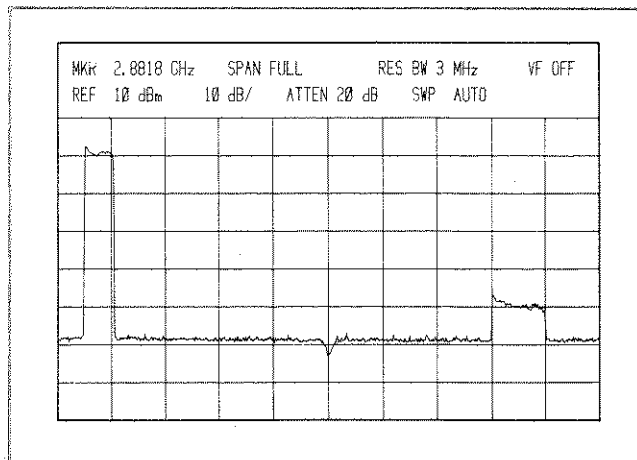

Figure 36. Oscillator Fundamental and Second Harmonic

NOTE

Consult AN 150-11 for more information on distortion measurements.

MODULATION

Amplitude Modulation

The wide dynamic range of the spectrum analyzer allows accurate measurement of modulation levels. A 0.06 percent modulation is a logarithmic ratio of 70 dB, which is easily measured with the HP 8569A. Figure 37 shows a signal with 2 percent AM displayed, a log ratio of 40 dB.

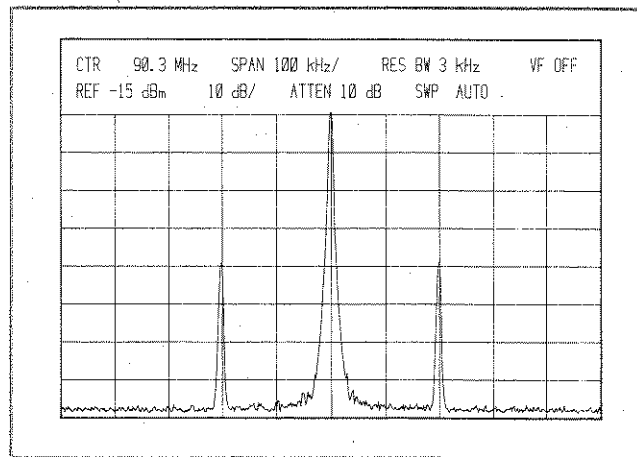

Figure 37. 2% AM

When the analyzer is used as a manually tuned receiver (Zero Span), the AM signal is demodulated and viewed in the time domain. To demodulate an AM signal, uncouple the RESOLUTION BW and set it to a value at least twice the modulation frequency. Then set the AMPLITUDE SCALE to LIN and center the signal,

horizontally and vertically, on the CRT. (Refer to Figure 38.) By pressing ZERO SPAN and VIDEO triggering, and adjusting the TRIGGER LEVEL for a stable trace, the modulation will be displayed in the time domain. (Refer to Figure 39.) The time variation of the modulation signal can then be measured with the calibrated SWEEP TIME/DIV control.

The example shown in Figure 39 demonstrates sinusoidal amplitude modulation, which can be used for narrowband sine wave testing of components and systems. In some cases, though, the modulation is not a pure sine wave; however, the HP 8569A can still be used to obtain signatures (reference responses) of random modulation for comparison, and as a fixed-tuned receiver whose vertical output (refer to Glossary) can be used for listening with headphones to the detected output. The display can be output to a controller for statistical analysis of random amplitude modulation.

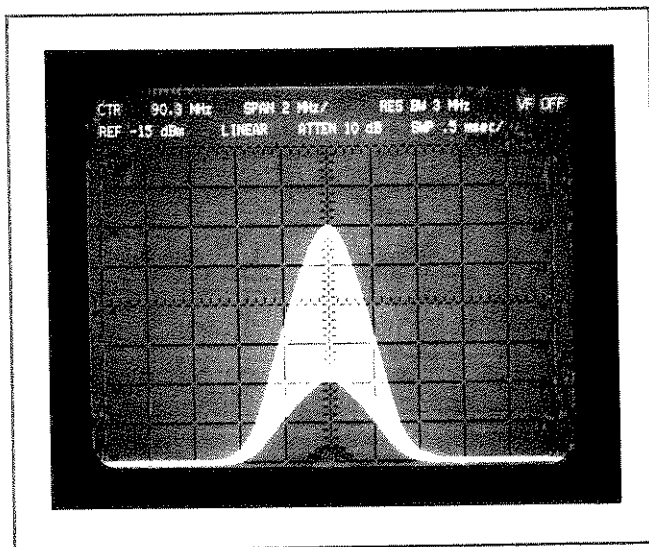

Figure 38. Linear Amplitude Display

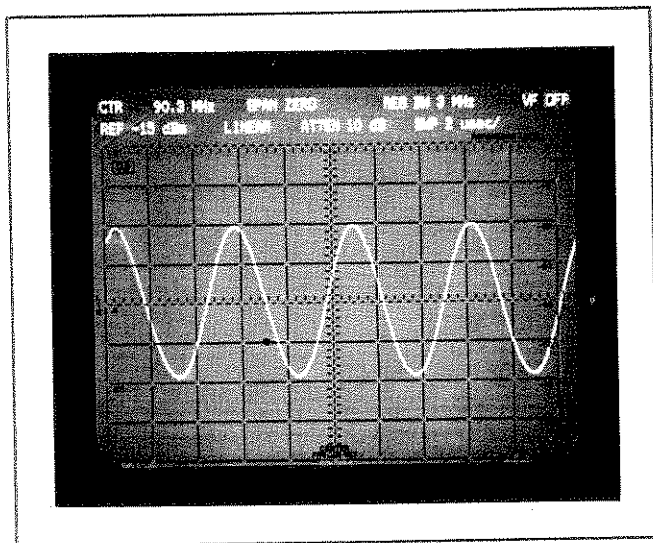

Figure 39. Demodulated AM Signal in ZERO SPAN

Frequency Modulation

For frequency modulated signals, parameters such as modulation frequency (f_m), modulation index (m), peak frequency deviation of carrier (Δf_{peak}) are all easily measured with the HP 8569A. The FM signal in Figure 40 was adjusted for the carrier null which corresponds to $m = 2.4$ on the *Bessel* function. The modulation frequency f_m , is 100 kHz, the frequency separation of the sidebands. The peak frequency deviation of the carrier (Δf_{peak}) can be calculated using the following equation:

$$m = \frac{\Delta f_{\text{peak}}}{f_m}$$

$$\text{or } \Delta f_{\text{peak}} = 2.4 \times 100 \text{ kHz} = 240 \text{ kHz}$$

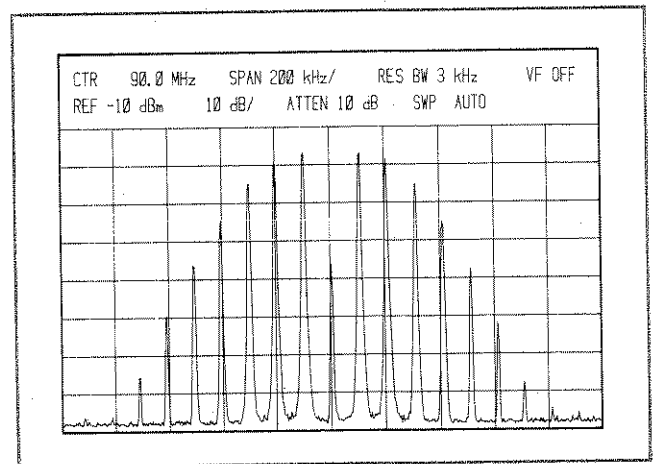

Figure 40. FM Signal

If the FM signal displayed does not correspond to a specific carrier or sideband null, then determination of the modulation index m , and final calculation of the peak frequency deviation Δf_{peak} , becomes much more complex and tedious. As with amplitude modulation, the display can be output to a controller. then, by storing in the controller memory the values of certain analyzer characteristics (such as slope non-linearities of bandwidth filters) and by prompting the user to set certain controls, Δf_{peak} can be measured directly or calculated.

Although the HP 8569A does not have a built-in discriminator, FM signals can be demodulated by slope detection. Rather than tuning the signal to the center of the CRT as in AM, the slope of the IF filter is tuned to the center of the CRT. At the slope of the IF filter, the frequency variation is converted to amplitude variation. In FM, the resolution bandwidth must be increased to yield a display similar to that shown in Figure 41 before switching to Zero Span. When Zero Span is selected, the amplitude variation is detected by the analyzer and displayed in the time domain as shown in Figure 42.

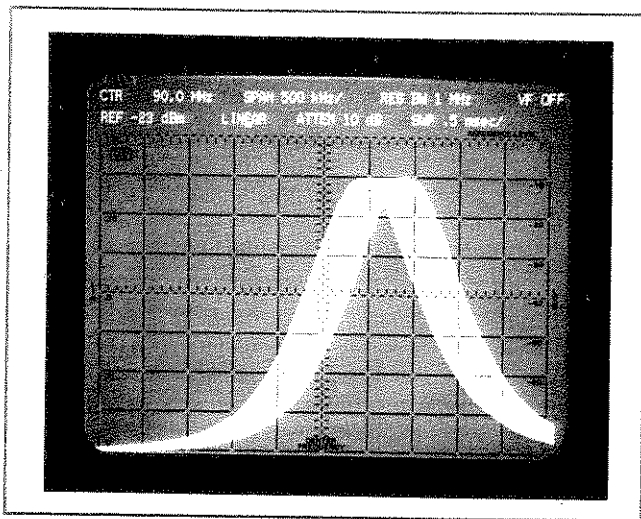

Figure 41. Slope Detection of FM Signal

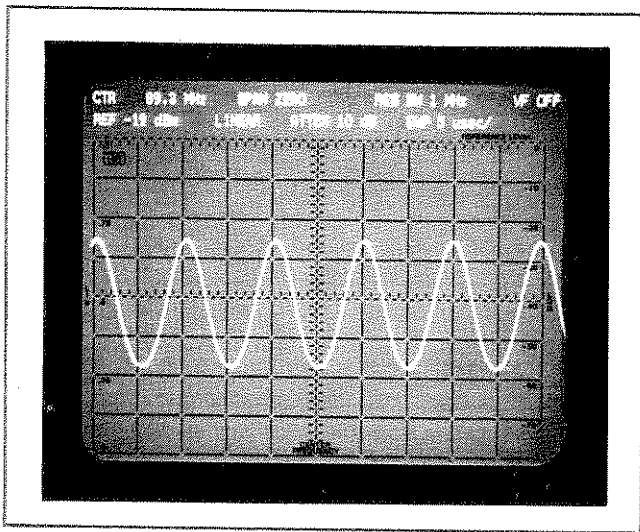

Figure 42. Demodulated FM Signal in ZERO SPAN

Pulsed RF

A pulsed RF signal is basically an RF signal which is turned on periodically for brief intervals of time. Some parameters to be determined in measuring pulsed RF signals are pulse repetition frequency (PRF), pulse width, duty cycle, on-off ratio of the modulator, and pulse power. Pulse power can refer to either the average power or to the peak power of the pulse.

The spectrum analyzer can display a pulsed RF signal in either of two modes, the line mode or the pulse mode. The factor that determines the display mode is the number of spectral components or lines that are in the passband of the spectrum analyzer at any one time. In the line mode, there is only one spectral component or line in the passband; i.e., the resolution bandwidth is

less than the PRF. In the pulse mode, there is more than one spectral line in the passband; i.e., the resolution bandwidth of the analyzer is greater than about twice the PRF.

Since a spectrum analyzer does not display the actual peak pulse power of the signal (a pulsed signal has its power distributed over a number of spectral components and each component represents a fraction of the peak pulse power), a correction or a desensitization factor must be added to the displayed main lobe power of the pulsed RF signal to obtain the peak pulse power. The calculation of the desensitization factor depends on whether the analyzer is displaying the signal in the line or pulse mode.

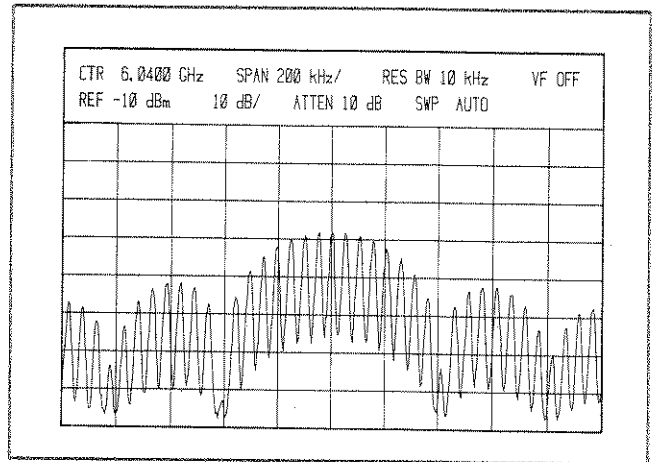

Figure 43. Line Spectrum

Line Mode

To obtain a *line* spectrum on the analyzer, the rule of thumb to follow is that the resolution bandwidth must be less than the PRF. This ensures that individual spectral lines will be resolved. From the line spectrum shown in Figure 43, it is possible to measure the following parameters:

$$\text{PRF} = 50 \text{ kHz (spacing between spectral lines)}$$

$$\text{Main lobe width} = 800 \text{ kHz}$$

$$\text{Main lobe power} = -38 \text{ dBm}$$

Then, from the above measurement, the following data can be calculated:

$$\begin{aligned} \text{Pulse width} &= \frac{2}{\text{Main Lobe width}} \\ &= \frac{2}{800 \text{ kHz}} = 2.5 \mu\text{sec} \end{aligned}$$

$$\begin{aligned} \text{Duty cycle} &= \frac{2 \text{ PRF}}{\text{Main Lobe width}} \\ &= \frac{2(50 \text{ kHz})}{800 \text{ kHz}} = 0.125 \end{aligned}$$

To determine the peak pulse power in a line spectrum, a pulse desensitization factor (α_L) must be added to the measured main lobe power. The desensitization factor is a function of the duty cycle and is represented by the following equation:

$$\alpha_L = 20 \log x (\text{duty cycle})$$

For duty cycle of 0.125, $\alpha_L = -18$ dB. Hence the peak pulse power in Figure 43 is -20 dBm.

Pulse Mode

To obtain a pulse spectrum on the analyzer, the resolution bandwidth of the analyzer must be set to greater than about twice the PRF, to ensure that more than one spectral line is within the passband of the analyzer. To find the peak pulse power in the pulse mode, add the pulse desensitization α_p , which is a function of pulse width and spectrum analyzer impulse bandwidth, to the main lobe power.

Figure 44 illustrates a signal in the pulse spectrum mode. As with the line spectrum, the pulse width can be determined from the main lobe width, while the impulse bandwidth is a characteristic of the analyzer.

$$\alpha_p = 20 \log (\text{pulse width} \times \text{Impulse BW})$$

For a pulse width of $2.5 \mu\text{sec}$ and an impulse bandwidth of 150 kHz , $\alpha_p = -8$ dB. The peak pulse power of the signal shown in Figure 44 then, is -20 dBm.

Using the pulse spectrum enables a wider resolution bandwidth to be used. The wider resolution bandwidth provides two advantages: First, the signal to noise ratio is increased because the pulse amplitude increases linearly with the resolution bandwidth (BW) while random noise increases proportionally to the square root of the bandwidth ($\sqrt{\text{BW}}$). The only limitation is that the bandwidth should be no greater than about 5 percent of the main lobe width. Secondly, faster sweep times can be used because of the wider resolution bandwidths. The HP 8569A has a 3 MHz Resolution BW which enables it to effectively display pulsed RF signals in the pulse mode. The 3 MHz bandwidth, along with fast sweep times, also enables narrow pulse widths to be measured in the time domain. The demodulated pulse signal of Figure 44 is shown in Figure 45.

Few operating pulsed RF systems have ideal spectra. Measurements can still be made regardless of the asymmetry of the spectrum. Examples of non-ideal spectra are found in digital communications and radar.

Since most radar systems do not have ideal spectra, the spectrum of a properly operating system is often stored

away for future reference. This reference or spectral signature can then be used to determine changes that would indicate potential problems. The HP 8569A has the capability of storing display information onto magnetic tape via HP-IB or by directly plotting the information (hard copy) for use later (refer to Chapter 2).

In digital communications, one major concern is the limits placed on transmissions by regulatory agencies. When the HP 8569A is used with a controller, specification limits can be written directly onto the CRT, thereby making conformance testing less tedious.

An additional factor to consider when measuring pulsed RF signals is the VIDEO FILTER control and the digital averaging capability of the spectrum analyzer. In general, the VIDEO FILTER and DGT L AVG should

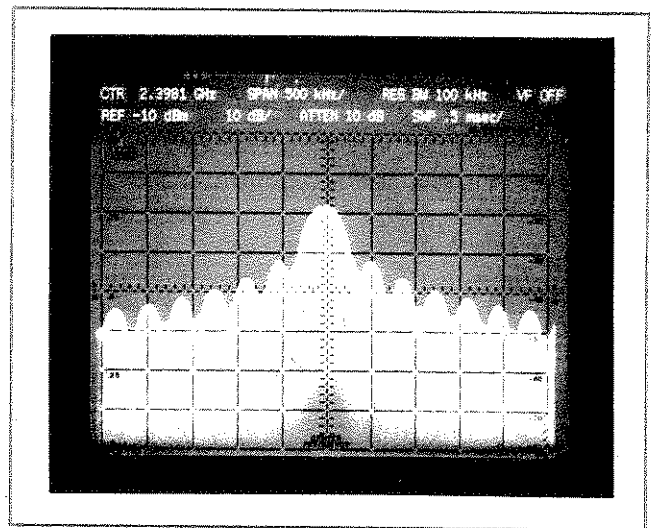

Figure 44. Pulse Spectrum

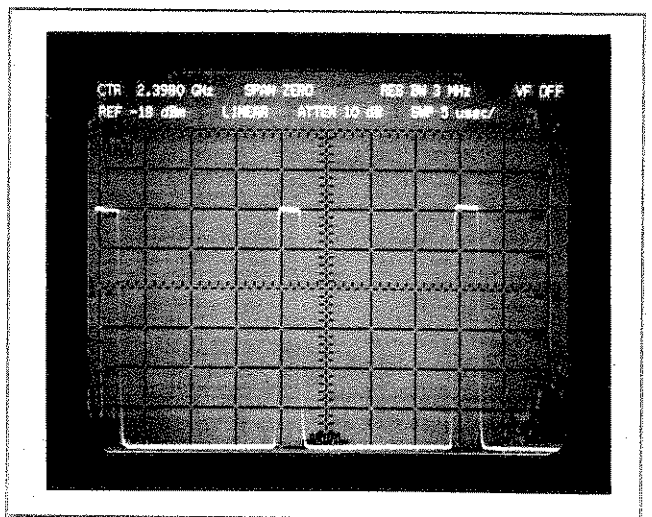

Figure 45. Demodulated Pulsed RF Signal in ZERO SPAN

be OFF when measuring pulsed RF signals. Adding video filtering or digital averaging will desensitize a pulsed signal and limit its displayed amplitude. Therefore, when monitoring pulsed signals in a full-band mode, it is important to use the F mode rather than the FULL BAND pushbutton mode. The FULL BAND pushbutton mode automatically engages a 9 kHz video (0.003 x 3 MHz) filter which will limit the displayed amplitude of the pulse bandwidth.

NOTE

Consult AN 150-2 for more information on pulsed RF measurements.

NOISE

Applications involving noise measurements include oscillator noise (spectral purity), signal to noise ratio, and noise figure. The NOISE AVG position of the VIDEO FILTER control and the digital averaging capability of the spectrum analyzer can be used to measure the analyzer sensitivity or noise power from 0.01 to 22 GHz.

The test setup in Figure 46 is used to make a swept noise figure measurement of an amplifier. First, the total gain of the amplifier under test and the pre-amp is determined. Then, the input of the amplifier is terminated and its

noise power is measured. The noise figure of the amplifier is the theoretical noise power (KTB) minus the total gain and the amplifier noise power. Figure 47 is a plot of an amplifier's noise power output.

Another technique, called the Y-Factor Technique (refer to Figure 48), overcomes the problems associated with the analyzer's absolute accuracy by using a calibrated noise power standard such as the HP 346B excess noise source. by measuring the ratio of P_o with the noise source On, to P_o with noise source Off (the test amplifier input terminated in Z_o impedance) we can determine Noise Figure to a much greater accuracy. Spectrum analyzer *instrument* errors in the measurement of P_o On/ P_o Off are typically less than a few tenths of a dB, leading to measurement accuracies approaching those of a noise figure meter. Figure 49 shows the results of a Y-Factor measurement.

NOTE

Consult AN 150-4, AN 150-7 and AN 150-9 for more information on noise measurements.

ELECTROMAGNETIC INTERFERENCE (EMI)

The objective of EMI measurements is to ensure compatibility between devices operating in the same vicinity.

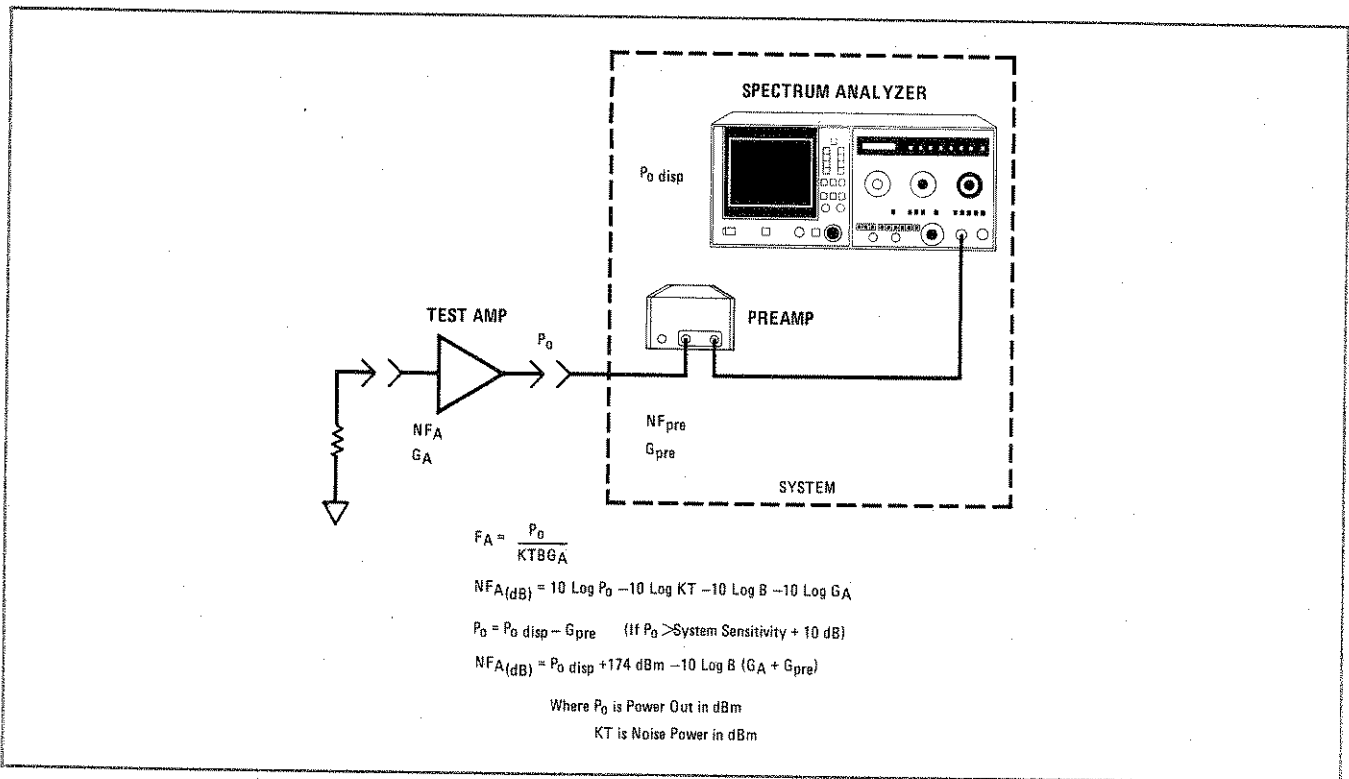

Figure 46. Measuring Noise Figure—Absolute Power Technique

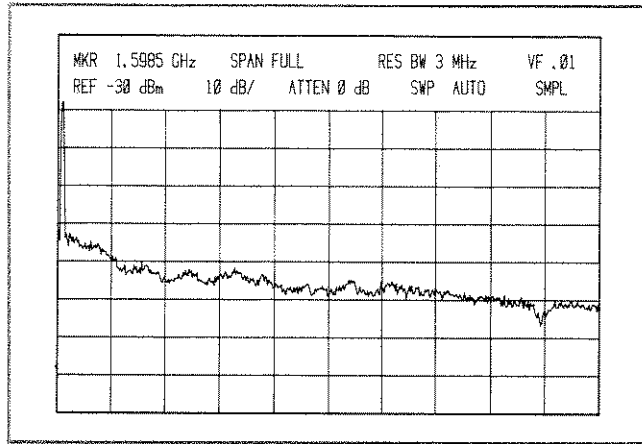

Figure 47. Noise Power Measurement

The HP 8569A, along with an appropriate transducer, is capable of measuring either conducted or radiated EMI and can also be used as a calibration tool for EMI susceptibility testing. Figure 50 illustrates an equipment setup used for measuring radiated field strength.

The antenna in Figure 50 is used to convert the radiated field to a voltage for the analyzer to measure. The field strength is the analyzer reading plus the antenna correction factor. Figure 51 illustrates radiated interference as displayed on the HP 8569A.

Compatibility is also important for high-frequency circuits which are in close proximity to each other. In a multi-stage circuit, parasitic oscillation from one stage can couple to a nearby stage and cause unpredictable

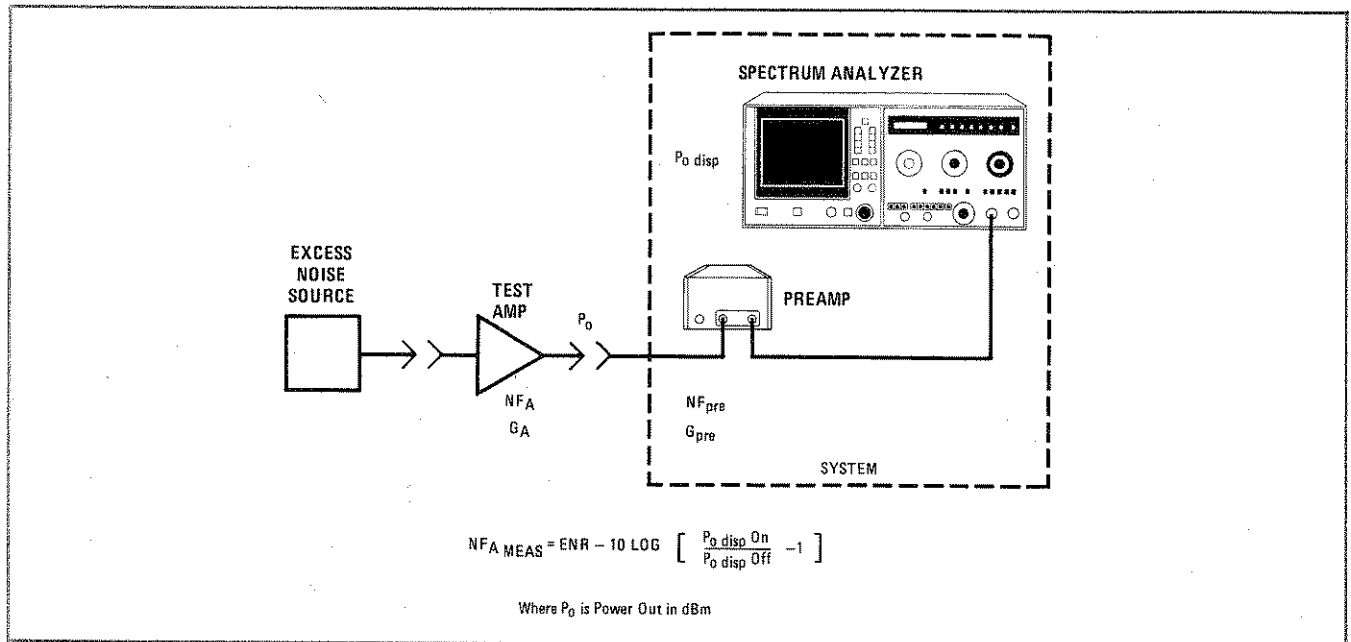

Figure 48. Measuring Noise Figure - Y Factor Technique

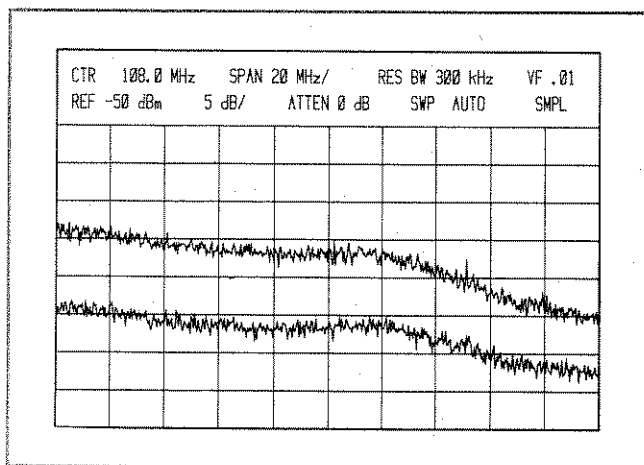

Figure 49. Y-Factor Measurement

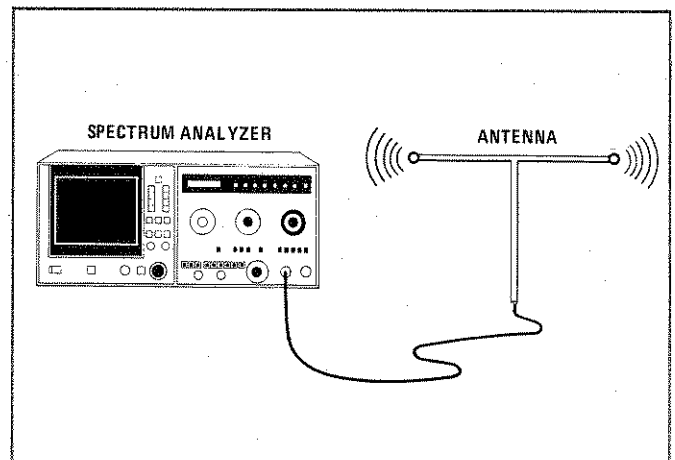

Figure 50. Field Strength Test Setup

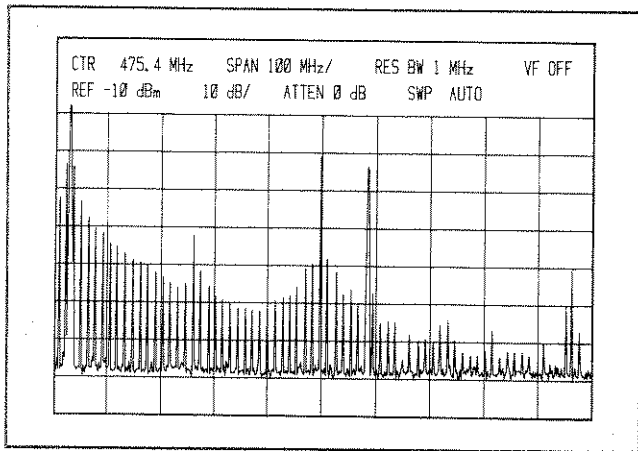

Figure 51. Radiated Interference

behavior. A popular technique used to search for spurious radiation is with an inductive loop probe. The loop probe is a few turns of wire that attaches to the spectrum analyzer with a flexible coaxial cable. (Refer to Figure 52.)

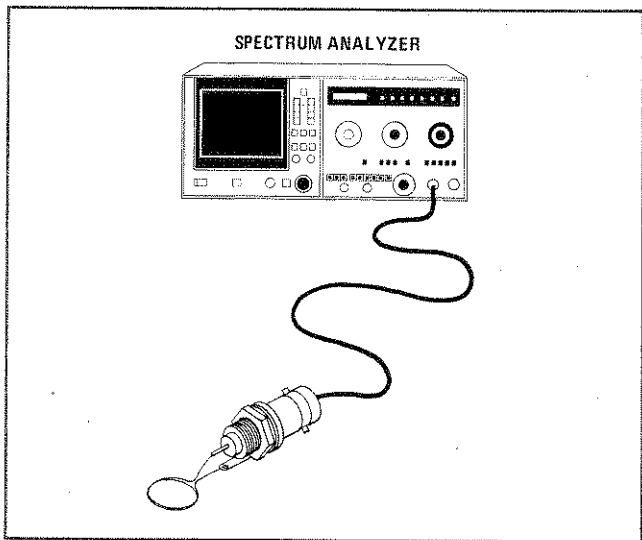

Figure 52. Loop Probe

Various parts of the circuit can be 'probed' to identify the location as well as the frequencies and relative amplitudes of spurious signals. Once the spurious signal has been identified, design techniques can be implemented to reduce or eliminate the cause of interference.

When testing to detailed specifications (i.e. MIL-STD), it is the worst case limits or the peaks of the signals that are of concern. MAX HOLD can be used to store the maximum amplitudes of these signals for later comparison to specified limits.

With interface to a desktop computer, the HP 8569A spectrum analyzer can output data automatically and

reformat the display to include test limits with the required impulse bandwidth normalizations and antenna factor or current probe corrections.

NOTE

Consult AN 150-10 and AN 142 for more information on EMI measurements.

SWEPT-FREQUENCY RESPONSE

Frequency response measurements are a common requirement for many system components such as filters, amplifiers, and mixers. The addition of an appropriate source to the spectrum analyzer makes a powerful system for stimulus (Swept-Frequency) response measurements.

The HP 8444A Option 059 is a tracking generator whose RF output frequency follows (tracks) the tuning of the HP 8569A spectrum analyzer over the frequency range of .010 to 1.5 GHz. Since the first local oscillator from the spectrum analyzer is used as a reference by the tracking generator, the low residual FM of the spectrum analyzer is transferred to the tracking generator. The frequency spans of the two instruments are matched and synchronous, providing precise tracking between the two instruments. The equipment setup for this measurement is shown in Figure 53.

A significant advantage of the spectrum analyzer/tracking generator combination for swept measurements is the large dynamic range. The noise is bandwidth limited in the spectrum analyzer, and harmonics and spurious products are not limiting factors since the spectrum analyzer is always tuned to the fundamental of the tracking generator. The dynamic range for the tracking generator and spectrum analyzer extends from the output available on the tracking generator to the noise floor on the analyzer. For the HP 8569A/8444A Opt 059 system, the dynamic range is generally greater than 100 dB. Figure 54 illustrates the large dynamic range that is possible using the HP 8444A Option 059 and the HP 8569A.

The system frequency response can be eliminated from the measurement results by using the INP-B mode. First, calibrate the system with a known standard (i.e., a through-line for transmission measurements). Then, store the displayed response in Trace B by using either STORE VIEW or STORE BLANK (see Figure 55a). Next, insert device under test, press INP-B-A (see Figure 55b). The displayed frequency response is that of device, not of system plus device (refer to Appendix D concerning position of Reference Line).

NOTE

Errors due to mismatch uncertainty are not removed from measurement by normalization.

The 8444A Option 059 can be used with a counter to make accurate, highly sensitive and very selective frequency measurements of unknown signals. Providing a signal can be resolved on the spectrum analyzer, it can

be counted. The system can count signals down to the sensitivity of the analyzer with the frequency accuracy several orders of magnitude better than the spectrum analyzer accuracy.

NOTE

Consult AN 150-3 and AN 150-13 for more information on Swept-Frequency Response measurements.

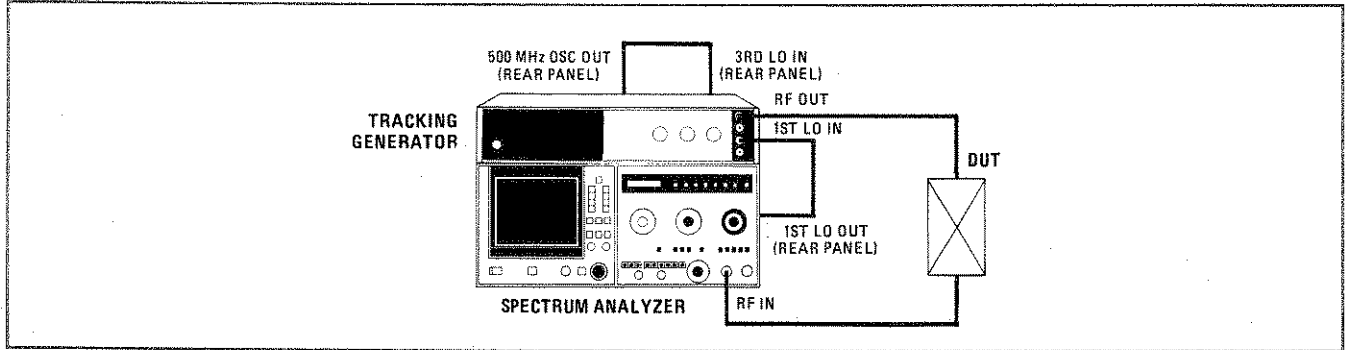

Figure 53. Swept Frequency Response Setup

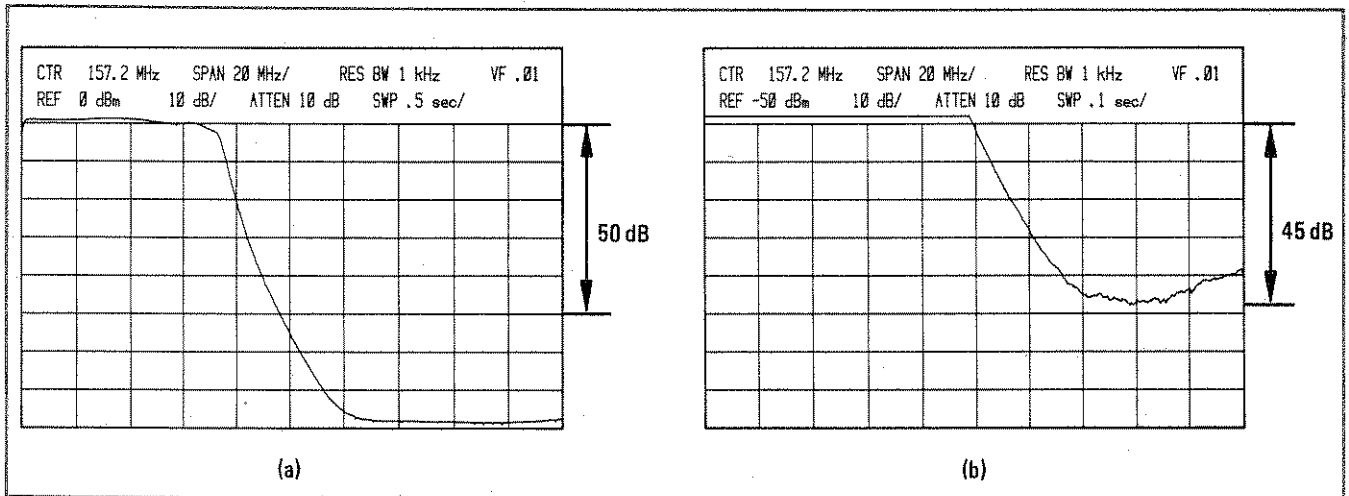

Figure 54. Low Pass Filter Measurement with 95 dB of Rejection

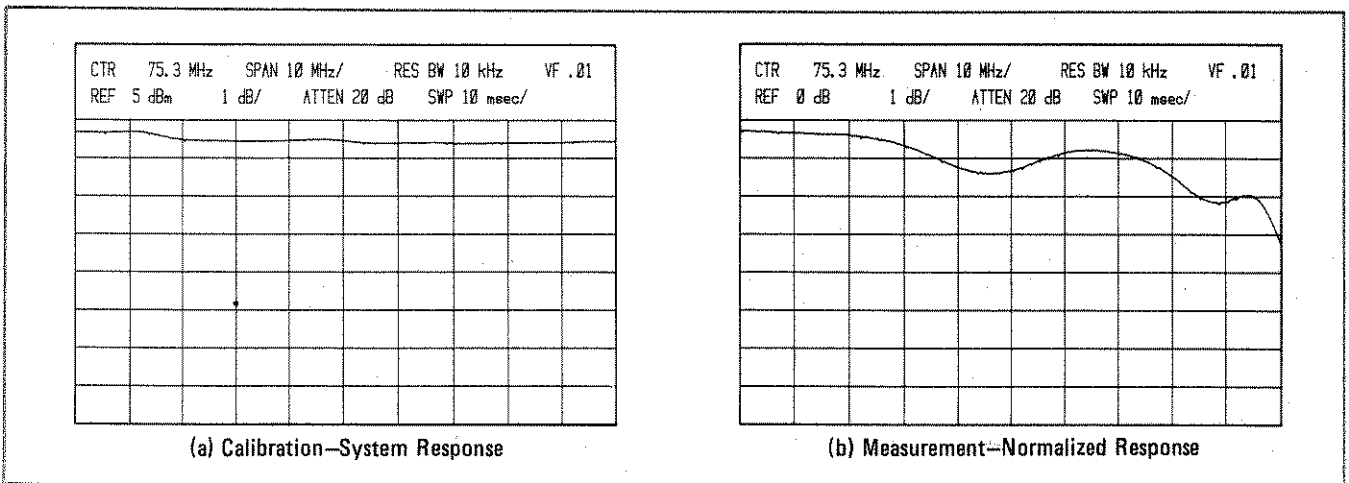

Figure 55. Normalization of Frequency Response

CHAPTER 5 HP-IB REMOTE OPERATION

This chapter discusses the requirements for remote operation of the spectrum analyzer using an HP-IB⁵ controller.

General Description

The HP 8569A digital storage display and sweep control can be accessed through HP-IB. The HP-IB connector is located on the rear panel (see Figure 56). An HP-IB interconnection cable (often supplied with the HP-IB Interface) is required to connect the analyzer to the controller HP-IB interface.

Programming codes are summarized on the pull-out information card and in Table 7 of this section. A more detailed syntax summary can be found in Appendix E. Programming information dealing with specific HP-IB controllers can be found in the *Introductory Operating Guide* addressing that specific controller.

HP-IB Compatibility

The complete bus capability of the spectrum analyzer as defined in IEEE STD 488 (or the identical ANSI Stan-

⁵Hewlett-Packard Interface Bus, the Hewlett-Packard implementation of IEEE STD 488-1975 and ANSI STD, MC 1.1, 'Digital Interface for Programmable Instrumentation.'

dard MC 1.1), is presented following Table 6. The programming capability of the instrument is further described by the three HP-IB messages in Table 6. Foremost among these messages is the data message, which is the primary method of communication between the analyzer and the controller. The responses of the analyzer to other messages are shown as well.

Addressing the Spectrum Analyzer

Communication between instruments on the HP-IB requires that a unique address be assigned to each instrument. The address switch (Figure 57) on the rear panel of the analyzer is used to set the analyzer address.

The instrument address is the binary number represented by the on (1) or off (0) states of the five switch segments (A1 through A5). For example, the address 18 is set when A2 and A5 are on (1) and the other switch segments are off (0).

Digital CRT Display Coordinates

References to the CRT display coordinates (specifically, commands AP/BP, BA/BB, IA/IB, and TA/TB as listed in Table 7) will follow the layout in Figure 58.

Within the range of the graticule, there are a total of 481 X-axis values (0 to 480, with 48 points per division) and 801 Y-axis values (0 to 800, with 100 points per division). The Y-axis overrange values displayed above the top of the graticule are 801 to 820 for the trace output

Table 6. HP-IB Message Reference Table

HP-IB Message	Response	Related Commands and Controls*	Interface Functions*
Data	Information pertaining to the digital storage display is available to the bus. Trace data and display messages can be sent to the analyzer via HP-IB. Program instructions can initiate sweeps.		T7, L4 AH1, SH1
Clear	Device clear; clear active traces and reset sweep.	DCL SDC	DC1
Abort	Interface clear; unaddress instrument.	IFC	T7, L4

*Commands, Control lines and Interface Functions are defined in IEEE STD 488 (and the identical ANSI Standard MC1.1). Complete HP-IB capability is: SH1, AH1, T7, TE0, L4, LE0, SRO, RLO, PP0, DC1, DT0, C0, E2.

commands AP/BP, BA/BB, and TA/TB and 801 to 975 for the trace input commands IA/IB. (Values above 950 may be deflected off the top of the screen.)

Two lines of annotation near the top of the CRT display are controlled by the labeling commands CS, LL/LU, and AL/AU.

Table 7 is a summary of the HP 8569A HP-IB Programming Codes. For more detailed information concerning the front-panel controls of the analyzer, refer to Chapter 2. For information on syntax requirements, refer to Appendix E.

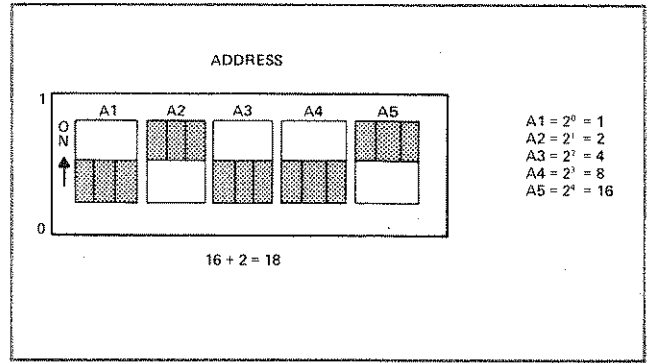

Figure 57. HP-IB Address Switch

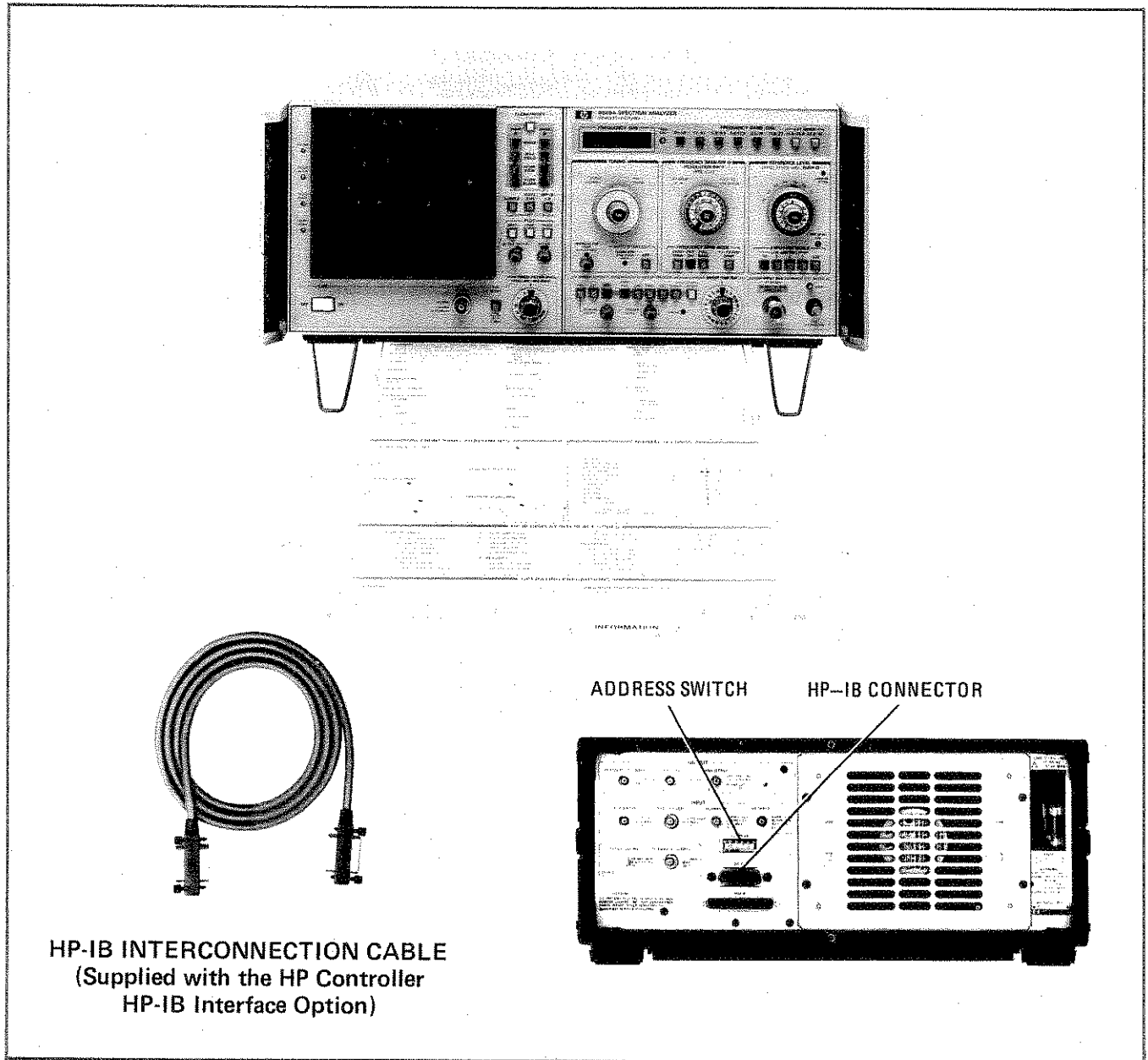

Figure 56. HP 8569A with HP-IB Interconnect Cable

Table 7. HP-IB Programming Codes

HP-IB Commands (Alphabetical Listing)			
AL	Display lower line control settings	LL	Input lower line message
AP	Output trace A peak signal coordinates	LU	Input upper line message
AT	Output RF Input Attenuation	MS	Output value of sweep flag
AU	Display upper line control settings	NS	Output INP-B→A state
BA	Output trace A byte values	RB	Output Resolution Bandwidth
BB	Output trace B byte values	RL	Output Reference Level
BP	Output trace B peak signal coordinates	SF	Start sweep and set sweep flag
CF	Output Center Frequency	SP	Output Frequency Span/Div
CS	Output annotation	ST	Output Sweep Time
DG	Output display mode	TA	Output trace A integer values
DM	Output detection mode	TB	Output trace B integer values
IA	Input trace A integer values	TS	Take sweep
IB	Input trace B integer values	VF	Output Video Filter
LG	Output Amplitude Scale		

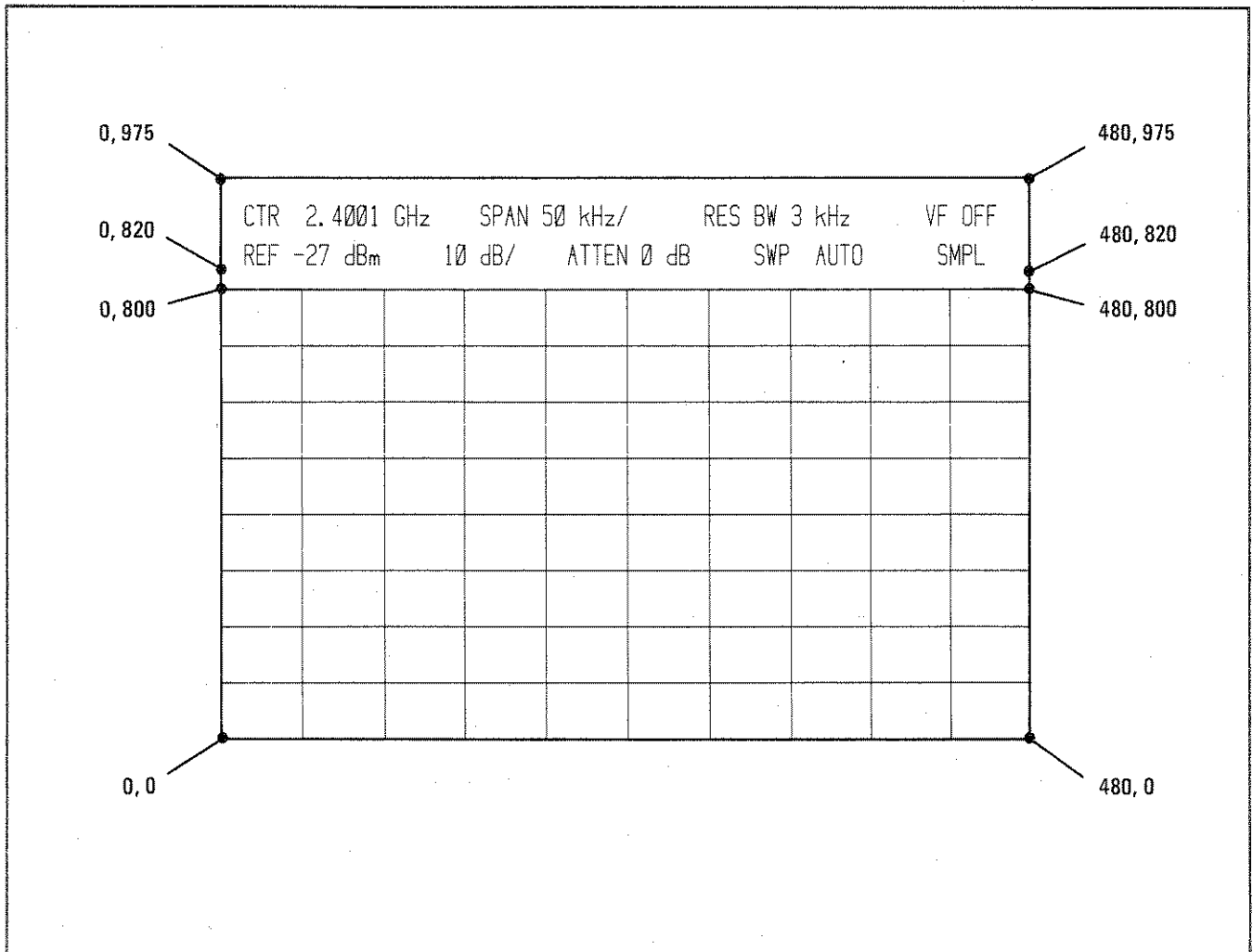

Figure 58. Display Coordinates

APPENDIX A OPERATING PRECAUTIONS

WARNING

This instrument and any device connected to it must be connected to power line ground. Failure to ensure proper grounding may cause a shock hazard to personnel or damage to the instrument.

The spectrum analyzer is a sensitive measuring instrument. To avoid damage to the instrument, do not exceed the following **absolute maximum input levels**:

- Total RF power: +30 dBm (1 watt)
- dc or ac ($<< 50\Omega$ source impedance):
 - 0V with 0 dB input attenuation (< 1 amp); $\pm 7V$ with ≥ 10 dB input attenuation (< 0.14 amp).
- Peak pulse power: +50 dBm (< 10 μ sec pulse width, 0.01% duty cycle) with ≥ 20 dB attenuation.

NOTE

Overdriving the input with too much power, either peak or dc voltages, might damage the input circuit and require expensive repairs.

If large dc components are present with ac signals, a blocking capacitor should be used at the INPUT of the analyzer to eliminate the dc components.

LOW IMPEDANCE AC

A source with much less than 50Ω nominal output impedance can produce excessive current which might damage the input circuit of the analyzer.

DC PRECAUTIONS

The HP 8569A *cannot* accept dc voltages in 0 dB INPUT ATTEN. With 10 dB or greater INPUT ATTEN, small dc voltages ($< \pm 7V$) can be accepted without damage if the total power (ac and dc) does not exceed 1 watt.

The input is direct-coupled and its dc input resistance varies from 0 to 87Ω , depending on the settings of INPUT ATTEN and FREQUENCY BAND GHz controls. (See Figure 59.)

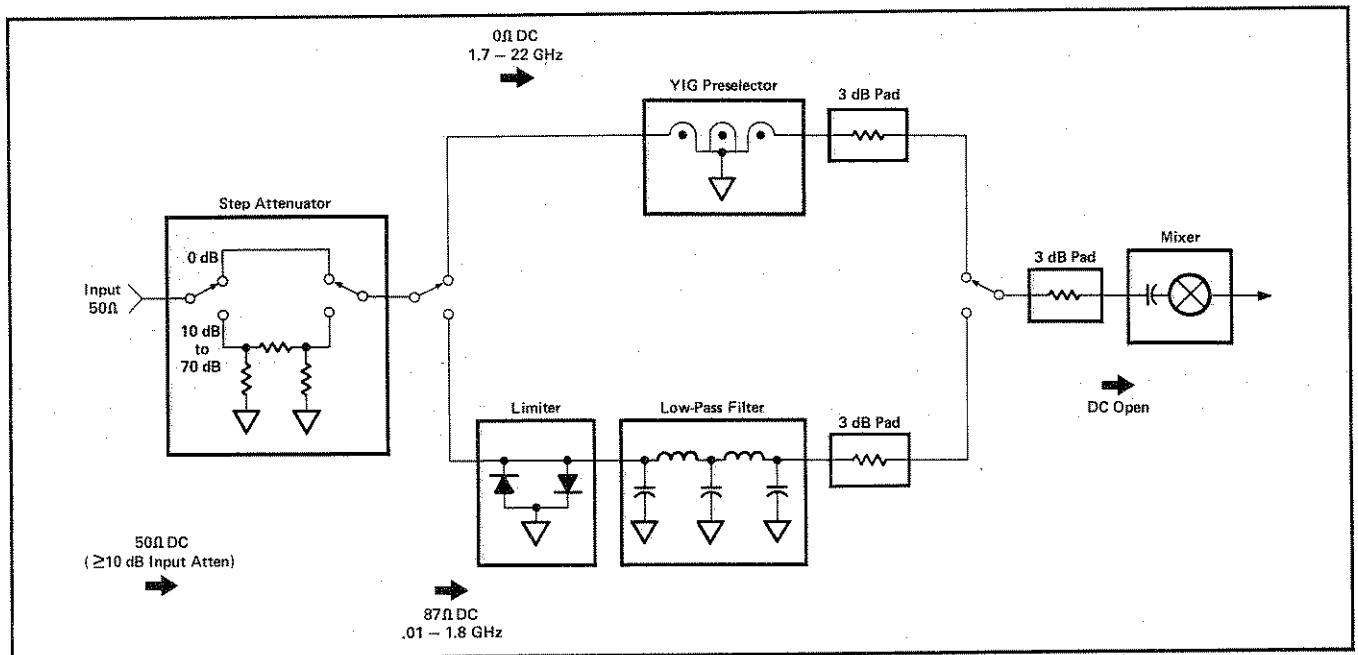

Figure 59. DC Block Diagram

APPENDIX B

THEORY OF OPERATION

SYSTEM DESCRIPTION

The Model HP 8569A Spectrum Analyzer is basically an electronically swept superheterodyne receiver. It has high sensitivity and selectivity, a wide, distortion-free dynamic range, and excellent flatness from 10 MHz to 22 GHz. With external mixing, frequency coverage can be extended up to 40 GHz using the HP 11517A and up to 170 GHz using commercially available mixers. The HP 8569A consists of an RF and an IF section, an automatic stabilization and control section, and a digital storage display section. These sections will be discussed separately in this appendix. Figure 60 is a simplified block diagram of the instrument.

RF SECTION

The RF section is composed of a 0—70 dB step attenuator, an automatic preselector, a tunable local oscillator (LO), and a broadband mixer. The step attenuator at the input to the spectrum analyzer is used to control the signal level to the mixer for optimum dynamic range and signal-to-noise ratio. The automatic preselector consists of a low-pass filter from 0.01 to 1.8 GHz and a YIG-tuned filter (YTF) from 1.7 to 22 GHz. Coaxial RF switches are used to switch to the proper filter, depending on the selected frequency band. The automatic preselector greatly reduces most image, multiple, and spurious responses of the analyzer and thus enhances its dynamic range. A transistorized YIG-tuned oscillator (YTO) with a fundamental tuning range of 2.05 to 4.46 GHz is used as the LO in this superheterodyne system.

The basic frequency conversion equation for a heterodyne system is given in equation 1:

$$F_S = F_{LO} \pm F_{IF} \quad (1)$$

where:

F_S = signal frequency

F_{LO} = local oscillator frequency

F_{IF} = intermediate frequency

The first IF in the HP 8569A is set at 321.4 MHz, and the first LO sweeps from 2.0 to 4.46 GHz. Therefore,

from equation 1, F_S would cover approximately 1.68 to 4.14 GHz in fundamental operation. With harmonic mixing, the frequency range is extended to 40 GHz, as shown in equation 2:

$$F_S = NF_{LO} \pm F_{IF} \quad (2)$$

where:

$$N(\text{harmonic number}) = 1-, 2-, 3-, 4+, 5+, 6+, 10+$$

Each harmonic number creates a tuning curve, illustrated in Figure 61. Signal frequencies from 0.01 to 1.8 and 1.7 to 22 GHz are converted by the broadband internal mixer to a 2050 MHz IF and a 321.4 MHz IF, respectively. In the 1.7 to 22 GHz frequency range, the YIG-tuned filter tracks a particular tuning curve and thus eliminates spurious responses resulting from harmonic mixing. From 14.5 to 40 GHz, an external waveguide mixer is used to convert the input signals to a 2050 MHz IF, which is then further processed by the analyzer.

AUTOMATIC STABILIZATION SECTION

Many factors can limit the resolution of the spectrum analyzer. Among these are the stability and spectral purity of the local oscillator and the bandwidth and shape factor of the IF filter. Of these limitations, the most significant for microwave analyzers is usually the stability (residual FM or drift) of an oscillator. For this reason, the HP 8569A utilizes an automatic stabilization circuit that locks the YTO to a 1 MHz crystal reference oscillator. The lock is automatically engaged when frequency spans of 100 kHz/Div or less are selected. The AUTO STABILIZER can be disabled by a pushbutton switch located on the front panel. An added feature of the automatic stabilization circuit is the use of offset compensation to keep the signal of interest fixed on the CRT during stabilization. The circuit is designed so that the YTO is not moved when it is locked to the reference oscillator. Since there is no frequency shift in the YTO, there is no shift in the displayed signal. This eliminates the need for the user to retune the signal on the CRT once the instrument has been stabilized.

IF SECTION

The IF section consists of components in the signal path after the first mixer. The output from the first mixer is either 2050 MHz (for the .01 to 1.8 GHz and EXT MIXER bands), or 321.4 MHz (for all other bands). Signals at 321.4 MHz bypass the second converter, whereas a 2050 MHz signal would mix with the second LO at 1.7286 GHz to also produce a 321.4 MHz IF. At the third converter, the 321.4 MHz IF is amplified, filtered, and mixed with the third LO at 300 MHz to produce a final IF of 21.4 MHz. The output of the third converter goes to a variable gain amplifier, selectable bandpass filters, variable gain logarithmic amplifiers, and linear amplifiers. It is then detected. The detected video signal goes through a selectable video filter before it is sent to the display for digital processing. The IF bandpass filter, log and linear amplifiers, and video filter are all controllable from the front panel of the spectrum analyzer.

DIGITAL STORAGE DISPLAY

The Digital Storage Display section performs two major functions. The first, which is controlled by the CPU (Central Processing Unit), is to acquire, process, and store display data in memory (referred to as Stroke Memory). The second, which is controlled by the counter, is to retrieve data from stroke memory and to display it on the CRT.

Since the CPU can process only digital information, a Analog to Digital Converter is provided to convert analog signals to digital information. The rate at which data is acquired varies with the instrument sweep speed, which is set by the Sweep Generator. During normal operation, the CPU alternately takes samples of the horizontal and vertical signals; the horizontal (X) value determines the memory address at which the vertical (Y) value is stored.

The counter accesses Stroke Memory and transfers the acquired data into the Y Data Buffer. Control logic determines the time at which the Y Data Buffer will transfer its data to the Digital Y Generator, which converts the retrieved data to an analog voltage that is applied through the Y Amplifier to the vertical deflection plates of the CRT. The horizontal (X) signal is generated by the Digital X Generator. The Digital X Generator receives control signals, derived from the counter, and generates an appropriate ramp voltage that is amplified and applied to the horizontal deflection plates of the CRT.

The Z-Axis signal controls both the brightness and the blanking of the trace. The Digital Y Generator outputs stroke length information, which is then converted to a brightness signal. The signal is used so that long strokes will not be dimmer than short ones. All remaining blanking inputs and control logic inputs are combined to produce one blanking signal that controls the blanking of the CRT. Generation of the display characters, seen on the top portion of the CRT, is accomplished by the Character Generator (addressed by the Counter and Data Bus) and by the blanking circuitry.

The Digital Storage Display section also performs secondary functions that are integral to the operation of the instrument but are not necessarily involved with acquisition and display of X and Y signals.

Secondary functions performed by the CPU (with the Input/Output Interface) include response to display control pushbuttons, interpretation of instrument control switches, and operation of the HP-IB Interface. The CPU also plays a major role in the performance of an automatic internal instrument check routine, as well as other test routines that are used to adjust, verify correct operation, and troubleshoot the digital storage circuitry. (Refer to the HP 8569A Operation and Service Manual, Section VIII.)

TUNING CONTROL SECTION

The Tuning Control Section contains the Frequency Control, YIG Driver, Frequency Display Unit, Sweep Attenuator, and Sweep Generator.

The Sweep Generator provides a sweep voltage that is simultaneously applied to the horizontal (X) deflection amplifier, data converter, and sweep attenuator. The sweep attenuator, controlled by the FREQUENCY SPAN/DIV control, reduces the sweep voltage to the Frequency Control Unit to maintain a calibrated horizontal scale on the CRT. In addition, the tuning control voltage, which sets the center frequency of the analyzer, is also applied to the Frequency Control Unit, where it is summed with the attenuated sweep. The resultant signal is then applied to the YIG drivers. Both the YTF and the YTO have separate YIG drivers which are basically voltage-to-current converters. A preselector peak adjustment is used to control the offset of the YTF YIG driver circuit. It is adjusted to eliminate any amplitude uncertainty due to nonlinear tracking between the YTF and the YTO. The Frequency Display Unit displays the frequency represented by the center of the CRT display.

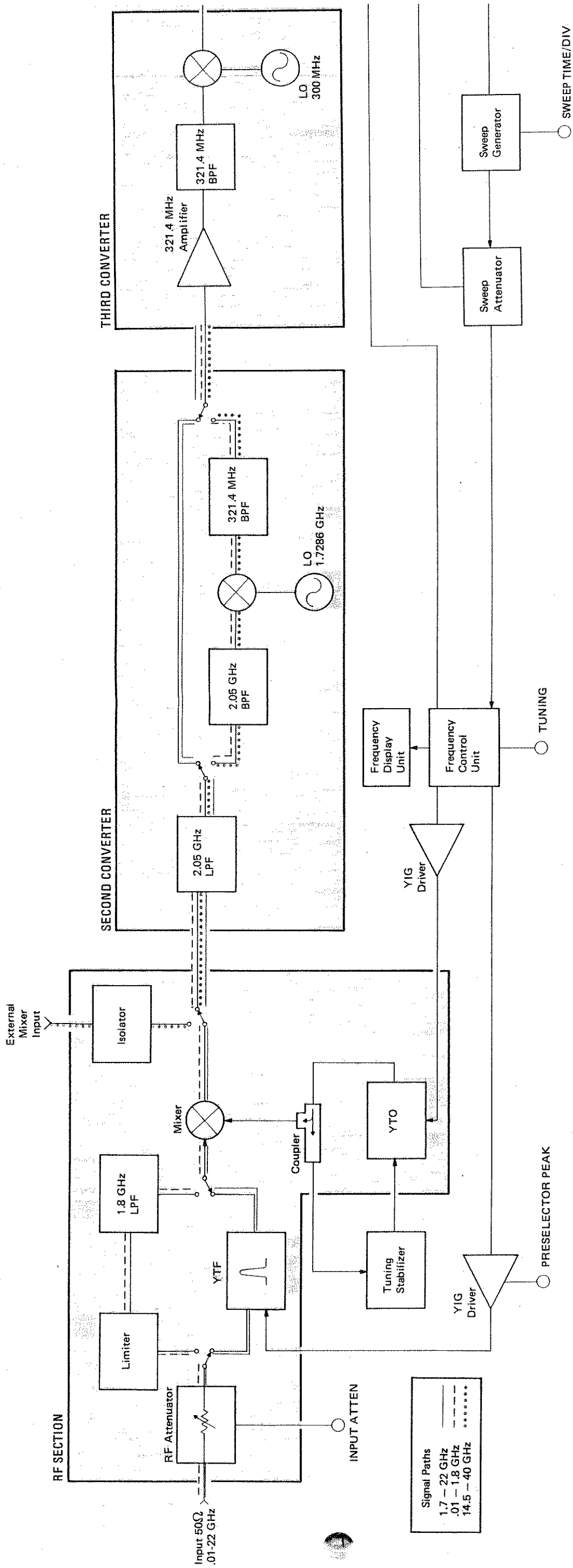

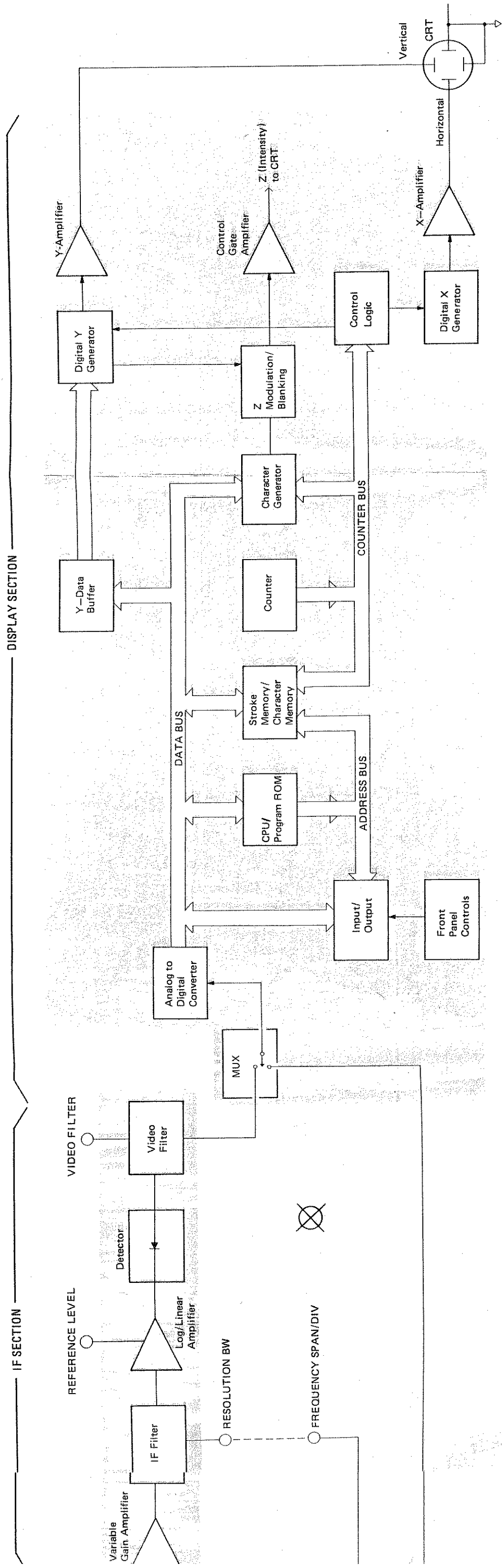

Figure 60. HP 8569A Block Diagram

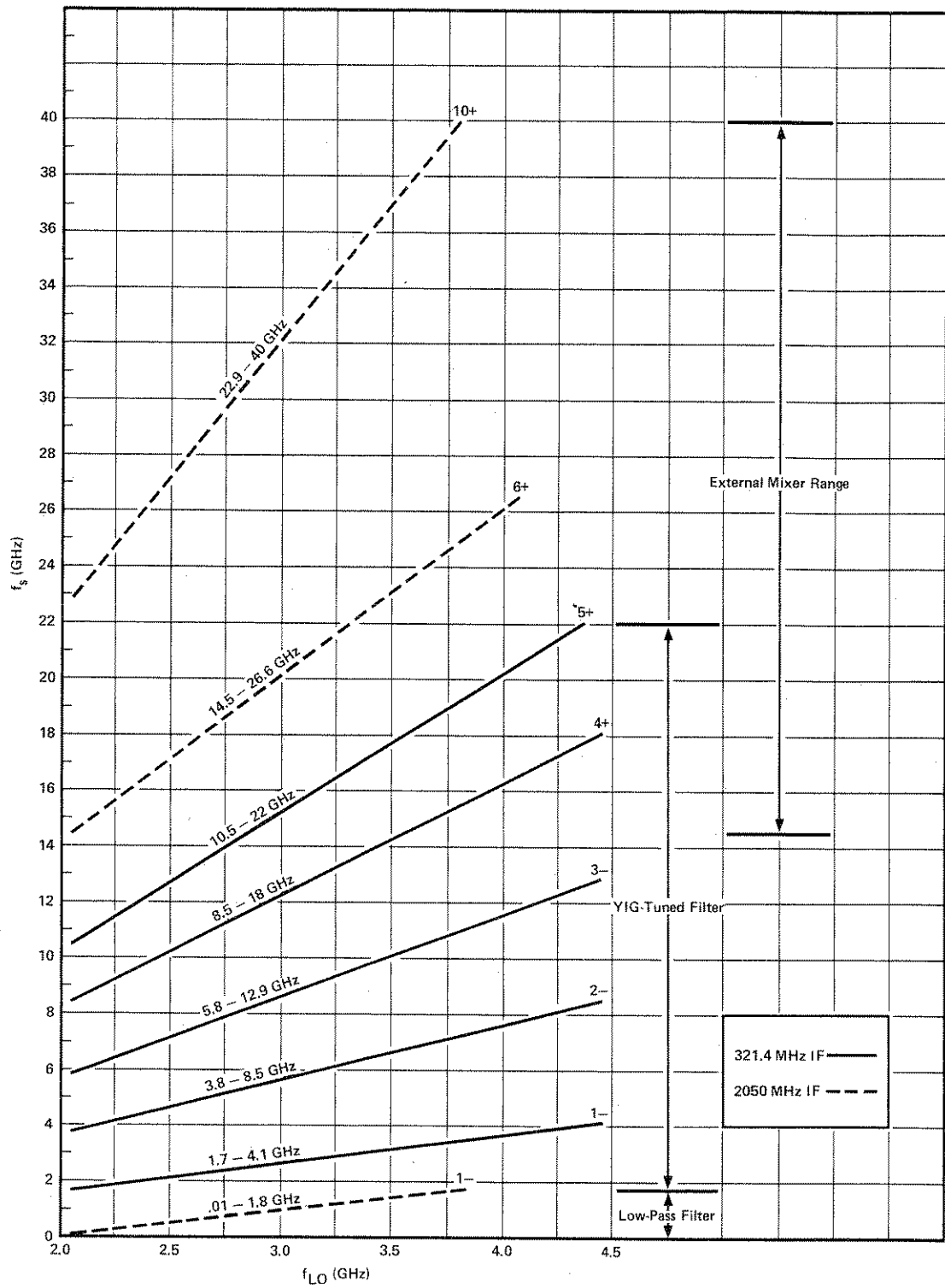

Figure 61. HP 8569A Tuning Curves

APPENDIX C AMPLITUDE CONVERSIONS

The Model HP 8569A Spectrum Analyzer reads signal levels in dBm. The following equations allow conversion from dBm to dBmV or dBV in a 50Ω system.

CONVERSION EQUATIONS

$$\text{dBm} + 107 \text{ dB} = \text{dB}\mu\text{V}$$

$$\text{dBm} + 47 \text{ dB} = \text{dBmV}$$

$$\text{dBmV} + 60 \text{ dB} = \text{dBV}$$

If it is desired to convert from logarithmic units to linear units, then the equations given below will be useful. Keep in mind that the logarithmic levels are all referenced to linear units.

That is:

- 0 dBm referenced to 1 mW
- 0 dBmV referenced to 1 mV
- 0 dBμV referenced to 1 μV

To calculate a linear level, simply take the antilog of the logarithmic level.

$$\text{dBm to } P(\text{mW})$$

$$\text{dBm} = 10 \log \frac{P}{1 \text{ mW}}, P = \log^{-1} \frac{\text{dBm}}{10}$$

$$\text{dBmV to } V(\text{mV})$$

$$\text{dBmV} = 20 \log \frac{V}{1 \text{ mV}}, V = \log^{-1} \frac{\text{dBmV}}{20}$$

$$\text{dB}\mu\text{V to } V(\mu\text{V})$$

$$\text{dB}\mu\text{V} = 20 \log \frac{V}{1 \mu\text{V}}, V = \log^{-1} \frac{\text{dB}\mu\text{V}}{20}$$

Figure 62 can be used to convert from dBm to voltage in a 50Ω system.

Conversion from dBm to volts can be made whether the AMPLITUDE SCALE is in LOG or LINEAR. To read voltage on the HP 8569A, position the signal on the REFERENCE LEVEL line of the CRT. Read the REF LEVEL in dBm and find its equivalent voltage from the conversion chart (Figure 62). The REF LEVEL calibration can be changed from dBm to dBμV by means of an internal jumper (Appendix D).

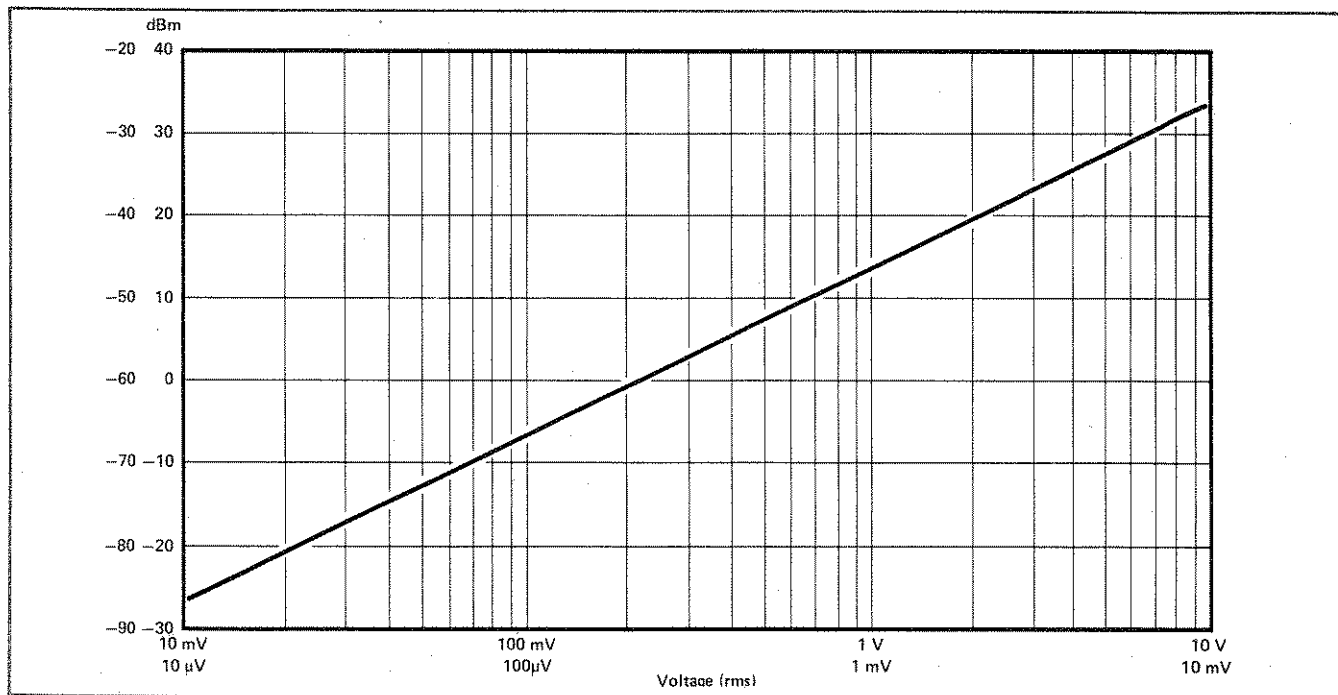

Figure 62. Conversion Chart - Converts from dBm to Voltage in 50Ω

APPENDIX D OPTION STATUS INTERFACE

Certain options on the HP 8569A can be enabled by means of a single jumper per option.

The jumper socket (J2) is part of the Option Status Interface, located on the A7 Input/Output Assembly. A diagram showing the location of J2 is shown in Figure 63.

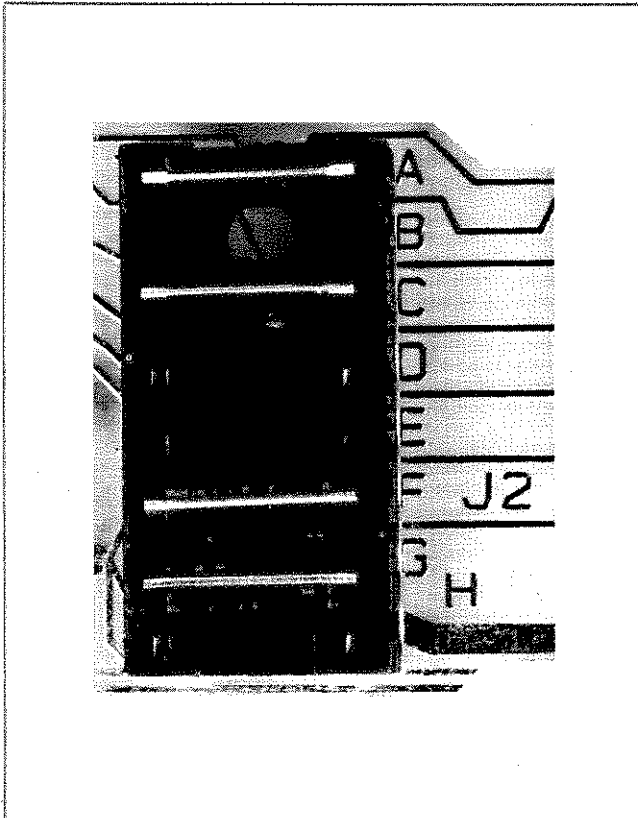

Figure 63. Option Status Jumpers

WARNING

Positioning of the option jumpers requires working on the instrument with protective covers removed and should be done only by a qualified service technician who is aware of the potential shock hazard. To avoid electrical shock, the line (mains) power cable should be disconnected before removing the protective covers from the spectrum analyzer.

Four (4) options are available on the OPTION STATUS INTERFACE.

1. Minimum Resolution Bandwidth
Pin A to Pin 1 (100 Hz Bandwidth)*
Pin B to Pin 2 (1 kHz Bandwidth)

NOTE

The Minimum Resolution Bandwidth option is not usable with Option 002 instruments.

2. Display Units – Reference Level
Pin C to Pin 3 (dBm)*
Pin D to Pin 4 (dB μ V)
3. Display Resolution – Center Frequency
Pin E to Pin 5 (100 kHz)*
Pin F to Pin 6 (1 MHz)
4. Reference Position for Normalized Response (INP–B→A)
Pin G to Pin 7*
(Center Horizontal Graticule Line)
Pin H to Pin 8
(Top Horizontal Graticule Line)

*No connection needed, default condition.

APPENDIX E HP 8569A SYNTAX REFERENCE GUIDE

This Syntax Reference Guide is intended to provide, in detail, the required forms of command to be used when addressing the analyzer from an external HP-IB controller, and to describe precisely the resulting HP-IB output from the analyzer. It is important to keep in mind that this guide is written from a controller point of view, as user-generated programs will always be executed in the controller, not in the spectrum analyzer.

A pictorial flow representation is used to delineate the sequence of bytes or blocks of traffic across the bus. Literal ASCII characters are bold and shown in rounded envelopes. These are transmitted exactly as shown. Items enclosed by rectangular boxes are blocks of bus traffic which require further explanation. Those used repeatedly are described immediately below; others are dealt with on a command by command basis.

Output UNL TA21 LA18: UNListen, Talk Address 21, Listen Address 18 (analyzer factory-set select code=18) (ASCII code: ?U2)

Enter UNL LA21 TA18: UNListen, Listen Address 21, Talk Address 18 (ASCII code: ?5R)

Additional Commands Additional analyzer commands (two letter mnemonics) may follow within the same "Output" statement

Note that data bytes passed across the bus originate from the controller (controller is talker) until an "Enter" block is transmitted at which time the analyzer generates any succeeding data (analyzer is talker).

In several cases, two commands are used in an identical fashion and are listed together. Each pair performs the same function either on lower or upper lines of text (e.g., AL and AU) or on Trace A or Trace B (e.g., AP and BP). Only the usage of the first command listed is described; the second command may simply be substituted in its place.

A reference in a command description to a "digit" should be understood to be the ASCII code for the character 1, 2, 3, 4, 5, 6, 7, 8, 9, or 0.

The analyzer is able to ignore extra delimiters such as **CR** (carriage return) and **LF** (linefeed) at several points in a command sequence to the analyzer. On the other hand,

every byte indicated as output from the analyzer, i.e., data which immediately follows an "Enter" block, must be read by the controller or the analyzer will not be able to resume normal operation.

All commands which return values to the controller, except for the binary transfer commands, BA, BB, and MS, are terminated by transmitting an LF with the interface bus line EOI (End or Identify) pulled true. The commands BA, BB, and MS send no terminating LF, but the EOI line is pulled true during transmission of the final byte of the returned data sequence. (The final byte is the 962nd byte for BA and BB and is the only byte for MS.)

Pressing RESET on HP-IB controllers generates an interface clear (IFC) command on the bus, which unaddresses the analyzer.

In case an illegal two-character mnemonic is entered (i.e., one which is not part of the analyzer's command set), a message appears on the upper annotation line:

SYNTAX ERROR

To remove the message, send a command AU, or press CLEAR/RESET and hold it in until the annotation returns to the control setting mode.

AL, AU Display lower line, display upper line control settings

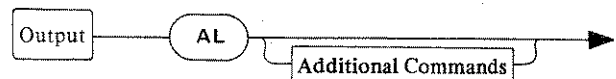

Returns labeling above graticule on CRT to the control setting mode after an LL or LU command. (AU = upper line, AL = lower line)

AP, BP Output coordinates of trace A, trace B peak

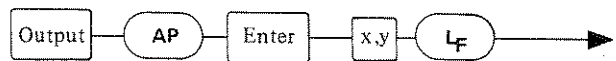

x,y: x,y coordinates (0-480, 0-820) of peak response on trace (AP = trace A, BP = trace B). Format is two 3-digit numbers separated by a comma:

$\underbrace{\text{d d d}}_x, \underbrace{\text{d d d}}_y$

If the peak value occurs at two or more horizontal positions, the leftmost point is returned.

AT Output RF Input Attenuation

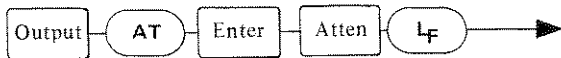

Atten: 0 to 70 for Attenuation in dB

AU See **AL**

BA, BB Output trace A, output trace B byte values

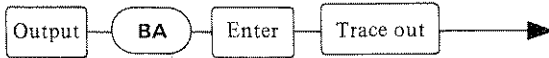

Trace out: 481 trace values (962 bytes) in double-byte format (BA = trace A, BB = trace B):

	ab	ab	ab	ab	ab
value number	1	2	3	480	481

where a and b are 8-bit bytes. 10 bits are required to specify trace values from 0 to 820 display units (800 is graticule full scale, 801-820 are overrange values). The first byte in each number, a, represents the most significant two bits and the second byte, b, represents the least significant eight bits of this 10-bit value. For example, to represent 820 the pair of 8-bit bytes would be:

a = 00000011
b = 00110100

Therefore, when a BA or BB command initiates a byte transfer over the interface, the resulting pairs of bytes must be recombined in the controller to yield meaningful data. Normally, the first byte is either shifted or rotated 8 bits to the left (or multiplied by $256 = 2^8$) and added to the second byte to effect the recombination.

BB See **BA**

BP See **AP**

CF Output Center Frequency

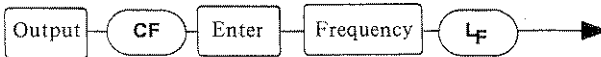

Frequency: -50000000 to 22600000000 for Center Frequency in Hz

CS Output annotation

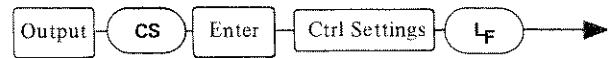

Ctrl settings: A 126-character string, represents two 63-character lines of control setting labels (or LL or LU generated labels) as they are displayed above the graticule on the analyzer CRT. Refer to LL, LU for a table of the character set.

DG Output display mode



Flag: = 0 for normal mode
= 1 for Digital Average mode

DM Output detection mode



Flag: = 0 for Peak Detection mode
= 1 for Sample mode

IA, IB Input trace A, input trace B integer values

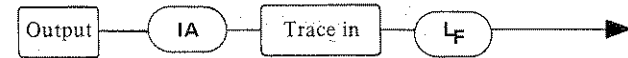

Trace in: Up to 481 values in the range 0-975 (only the integer portion of the absolute value of the number is used). Values will be displayed at the appropriate levels on the CRT except zero values, which will be blanked. The trace values are to be separated by commas, the last value followed by a semi-colon except when a full 481 values are sent, in which case the final semi-colon is optional. For example, 300 values input would look like this:

	v,	v,	v,	v,	v;
value number	1	2	3	299	300

where v = 1 to 3 digits

A carriage return before the terminating linefeed is optional and is ignored. If the trace values and commas are sent as a string, do not attempt to send additional commands following in the same 'Output' statement.

IB See IA

LG Output Amplitude Scale

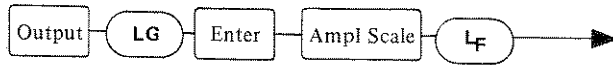

Ampli Scale: = 10, 5, 2, or 1 for LOG scale (dB/division)
= 0 for LINEAR scale

LL, LU Input lower line, input upper line message

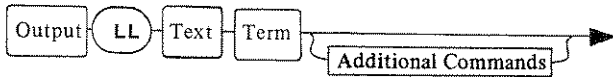

Text: Up to 63 ASCII characters to appear on upper line (LU) or lower line (LL) of labeling above graticule on CRT.

Term: An ASCII terminating character ETX, LF, CR or any byte in the range 0 to 31 decimal.

8569A Display Character Set

32* 63	!"#\$%&'()*+,-./0123456789:;<=>?
64-95	@ABCDEFGHIJKLMN O PQRSTU VWXYZ[\]^_`
96-127	~`abcdefghijklmnopqrstuvwxyz{ }~

*Character 32 is a blank.

LU See LL

MS Output value of sweep flag



Flag: = 0 for sweep completed
= 1 for sweep in progress

The MS (mid-sweep) flag should be used only following an SF command and refers only to the single sweep triggered by that command. If the MS flag is tested when there has been no SF command, the flag has no meaning and a zero value is returned.

NS Output INP-B→A state



Flag: = 0 for INP-B→A OFF
= 1 for INP-B→A ON

RB Output Resolution Bandwidth



Res BW: = 100 to 3000000 for Resolution Bandwidth in Hz

RL Output Reference Level



Ref Level: = 60 to -112 for Reference Level in dBm
= 167 to -5 for Reference Level in dBμV*
= 172 to -172 for relative level of center graticule in dB with INP-B→A ON

SF Start sweep and set sweep flag

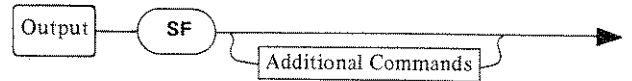

Triggers sweep, sets MS flag = 1. At completion of sweep, MS flag = 0. (SF may not be used when analyzer is in analog or mixed sweep mode.) During the sweep triggered by SF, the MS command may be used to test whether the sweep is in progress or complete. All other analyzer commands sent by the controller during the sweep for which the MS flag = 1 will be accepted and ignored by the analyzer. The MS command is the only command that has meaning during an SF-triggered sweep. See the example at the end of this appendix.

SP Output Frequency Span/Div



Span: = 1000 to 500000000 for Span in Hz/division
= 0 for Zero Span
= -1 for Full Span
= -2 for 1.7-22 GHz Span

*See Appendix D for conversion from dBm readout to dBμV.

ST Output Sweep Time/Div

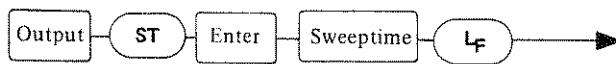

Sweeptime: = 2 to 10000000 for Sweeptime in μ s/division
 = -1 for AUTO sweep
 = -2 for MANual sweep
 = -3 for EXTernal sweep

TA, TB Output trace A, output trace B integer values



Trace out: 481 values in the range 000 to 820 (3 digits each including leading zeros), each value followed by a comma except the last value (1923 total bytes or ASCII characters).
 (TA = trace A, TB = trace B.)

value number v, v, v, v, v;
 1 2 3 480 481

where v = 3 digits

TB See TA

TS Take sweep

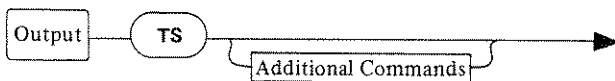

Triggers the analyzer to sweep and inhibits subsequent commands to the analyzer until that sweep is complete. Upon completion of the sweep, the analyzer resumes accepting commands normally. (TS may not be used when analyzer is in analog or mixed sweep mode.)

VF Output Video Filter

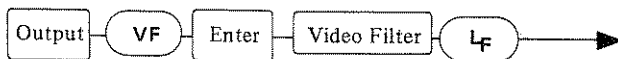

Video Filter: = .3 to .003 for ratio of VF to Res BW
 = -1 for VF 1 Hz (noise average)
 = -2 for VF OFF

An understanding of the interaction among six of the commands will facilitate their proper utilization in a user's program.

EXAMPLE 1

Two of these are SF and MS, which provide the user with additional flexibility in sweep control over that provided by the simpler TS command*. When the analyzer receives the ASCII mnemonic TS, a sweep is triggered and no further commands are accepted until the sweep is finished. This allows a programmer to instruct the analyzer to obtain trace data for the current control settings and input signal conditions without interference from any subsequent commands.

To permit parallel usage of the controller and other HP-IB equipment while the analyzer is sweeping, followed by end-of-sweep program branching, use SF and MS.

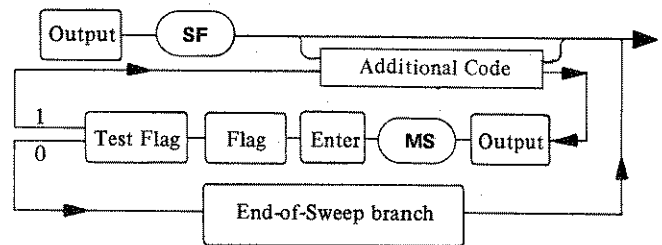

In the flow diagram, the SF instruction triggers a sweep and sets the MS flag = 1. The block Additional Code might represent digital processing of trace data from a previous sweep, or the execution of a separate measurement involving the controller and other instruments on the interface bus. If branching is desired at the end of the sweep (such as outputting the new trace data to the controller and triggering another sweep), the analyzer may be interrogated repeatedly to test the MS flag (the flag remains one for the duration of the sweep and then reverts to zero). Recognition of the zero condition leads to the 'End-of-Sweep branch' command.

It should be understood clearly that for the duration of an SF-triggered sweep (i.e., so long as the MS flag=1) only the specific instruction MS should be sent to the analyzer; any other command sent to the analyzer will be read and discarded. Therefore, resume sending other commands only after the MS flag has returned a zero.

*For this discussion the analyzer is assumed to be in single-sweep trigger mode while executing controller generated sweep instructions TS and SF.

EXAMPLE 2

The four remaining instructions requiring further explanation are two pairs; LL,LU and AL,AU. As LL with AL and LU with AU perform identical functions for their respective lines (lower and upper), only LL and AL is discussed.

Two lines of annotation are displayed above the etched CRT graticule. These may be the turn-on state in which the instrument control settings are displayed, or in a user-enabled state where the labeling lines have been input through the use of LL and LU. To reset the labels to the

control setting mode, AL and AU are provided. Thus, to place the label "8569A Spectrum Analyzer" on the lower line use:

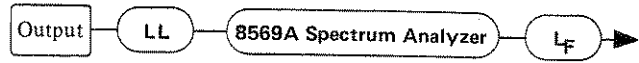

To subsequently reset the lower line to the control setting mode:



Supersedes: NONE

Quick Reference Guide 8569A Spectrum Analyzer

INTRODUCTION

This programming note is a reference guide for remote operation of the HP 8569A Spectrum Analyzer. This note is intended for use by those familiar with HP-IB programming and the basic functions of the HP 8569A Spectrum Analyzer. For complete programming information, refer to the HP 8569A Spectrum Analyzer Operation.

DIGITAL CRT DISPLAY COORDINATES

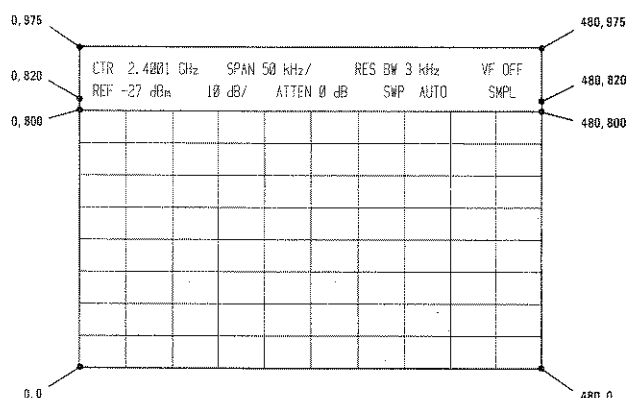

References to the CRT display coordinates (specifically, commands AP/BP, BA/BB, IA/IB, and TA/TB) will follow the layout in the above figure.

Within the range of the graticule, there are a total of 481 x-axis values (0 to 480, with 48 points per division) and 801 y-axis values (0 to 800, with 100 points per division). The y-axis overrange values displayed above the top of the graticule are 801 to 820 for the trace output commands AP/BP, BA/BB, and TA/TB, and 801-975 for the trace input commands IA/IB (values above 950 may be deflected off the top of the screen).

Two lines of annotation near the top of the CRT display are controlled by the commands CS, LL/LU, and AL/AU.

HP-IB COMMANDS (ALPHABETICAL LISTING)

AL	Display lower line control settings
AP	Output trace A peak signal coordinates
AT	Output RF Input Attenuation
AU	Display upper line control settings
BA	Output trace A byte values
BB	Output trace B byte values
BP	Output trace B peak signal coordinates
CF	Output Center Frequency
CS	Output annotation
DG	Output display mode
DM	Output detection mode
IA	Input trace A integer values
IB	Input trace B integer values
LG	Output Amplitude Scale
LL	Input lower line message
LU	Input upper line message
MS	Output value of sweep flag
NS	Output INP-B -- A state
RB	Output Resolution Bandwidth
RL	Output Reference Level
SF	Start sweep and set sweep flag
SP	Output Frequency Span/Div
ST	Output Sweep Time
TA	Output trace A integer values
TB	Output trace B integer values
TS	Take sweep
VF	Output Video Filter

HP-IB ADDRESS

The analyzer's HP-IB address is determined by means of a rear-panel switch. For example, for the address 18, the 16 and 2 switches are pressed up and all others down.

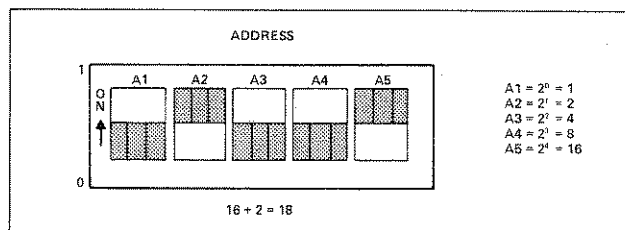

HP-IB COMMANDS (FUNCTIONAL LISTING)

LABELING

SWEEP CONTROL

- TS:** Triggers sweep (inhibits analyzer from accepting further commands until sweep is complete)
- SF, MS:** Triggers sweep, sets MS flag = 1; end-of-sweep condition signaled by setting MS flag = 0

CONTROL SETTINGS

- CF:** Center frequency in Hz,
= -50000000 to 22600000000
- SP:** Span,
= 1000 to 500000000 for Hz/division
= 0 for Zero Span
= -1 for Full Span
= -2 for 1.7-22 GHz Span
- RB:** Resolution bandwidth in Hz,
= 100 to 3000000
- RL:** Reference level,
= 60 to -112 for dBm
= 167 to -5 for dB μ V*
= 172 to -172 for relative level of center graticule in dB with INP-B-A ON
- AT:** RF input attenuation in dB,
= 0 to 70
- ST:** Sweeptime,
= 2 to 10000000 for μ sec/division
= -1 for AUTO Sweep
= -2 for MANual Sweep
= -3 for EXTernal Sweep
- DM:** Detection mode = 0 for PEAK
= 1 for SAMPLE
- DG:** Display mode = 0 for Normal
= 1 for Digital Average
- NS:** Normalize state = 0 for INP-B-A OFF
= 1 for INP-B-A ON
- VF:** Video filter,
= .3 to .003 for ratio of VF to Res BW
= -1 for VF 1 Hz (noise average)
= -2 for VF OFF
- LQ:** Amplitude scale,
= 10,5,2, or 1 for LOG scale (dB/division)
= 0 for LINEAR scale

*To convert to dB μ V, see Appendix D of 8569A Spectrum Analyzer Operation.

LL, LU: Up to 63 ASCII characters (see Table 1) input to lower line (LL), or upper line (LU), terminated with a linefeed

Table 1. 8569A Display Character Set

32*-63	!"#\$%&'()*+,-./0123456789:;<=>?
64-95	@ABCDEFGHIJKLMNPQRSTUVWXYZ[\]^_
96-127	`abcdefghijklmnopqrstuvwxyz{ }~* *Character 32 is a blank

AL, AU: Resets lower line (AL) or upper line (AU) annotation to control setting mode

CS: Outputs a 126-character string (see Table 1) which represents the 63-character upper and lower lines of annotation, terminated by a linefeed

TRACE DATA I/O

TA, TB: Outputs 481 trace values (000 to 820), 3 digits each separated by commas (1923 bytes total), terminated with a linefeed

BA, BB: Outputs 481 trace values in double-byte format (962 bytes total) e.g., 00000011 00110100 = 820 display units

IA, IB: Inputs up to 481 trace values in the range 0 to 975 (0 blanks trace) separated by commas, terminated with a semi-colon

AP, BP: Outputs peak coordinates (x,y) of trace A or trace B, terminated with a linefeed

STANDARD HP-IB MESSAGES

HP-IB Message	Response	Related Commands and Controls*	Interface Functions*
Data	Information pertaining to the digital storage display is available to the bus. Trace data and display messages can be sent to the analyzer via HP-IB. Program instructions can initiate sweeps.		T7, L4 AH1, SH1
Clear	Device clear; clear active traces and reset sweep.	DCL SDC	DC1
Abort	Interface clear; unaddress instrument.	IFC	T7, L4

*Commands, Control lines and Interface Functions are defined in IEEE STD 488 (and the identical ANSI Standard MC1.1).

Supersedes: NONE

Introductory Operating Guide for the 8569A Spectrum Analyzer with the 9825 Desktop Computer

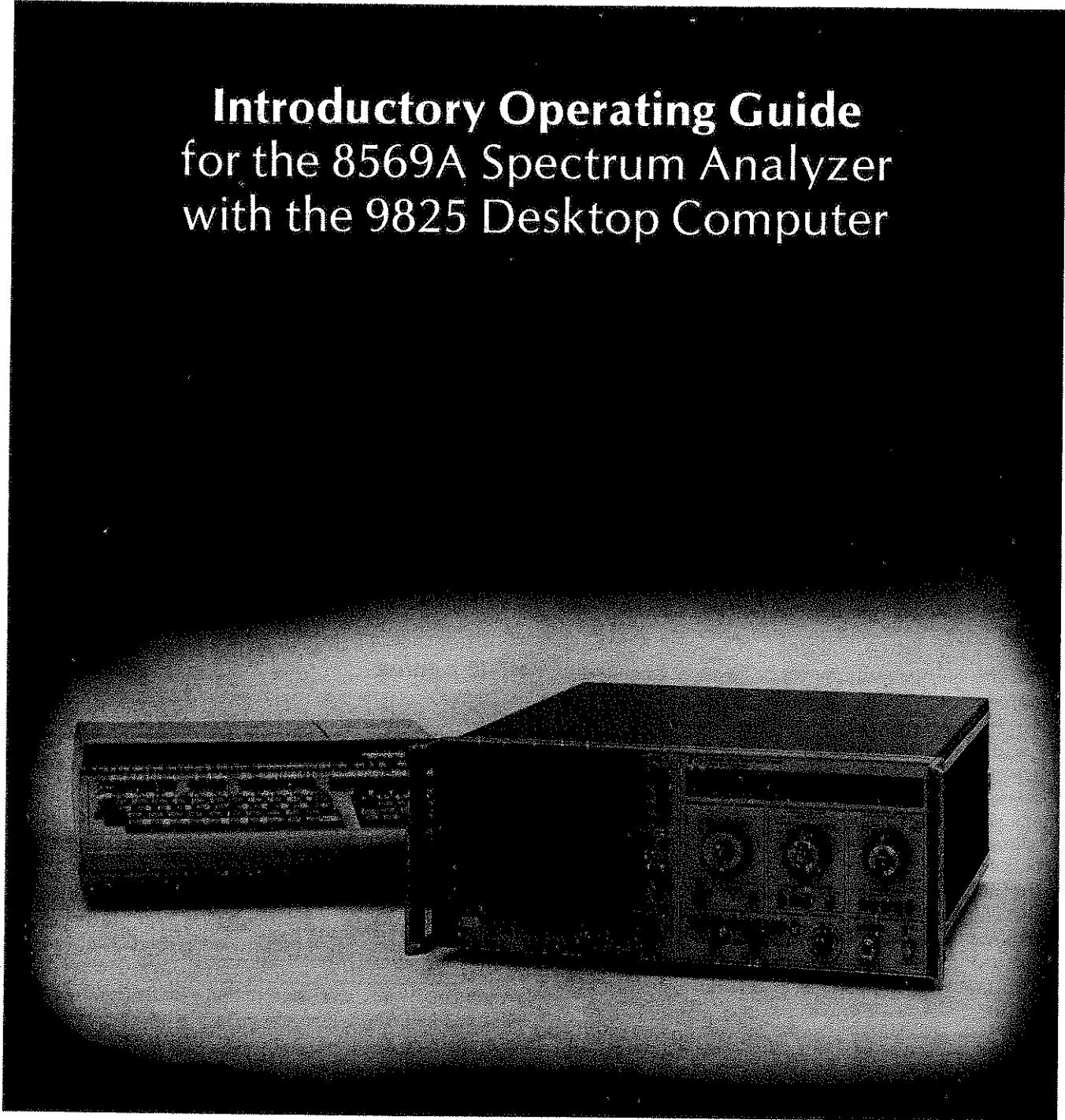

Introduction

This note is an introductory guide to remote operation and programming of the 8569A Spectrum Analyzer using a 9825 Desktop Computer. Included in this guide are system connections for remote operation and several example programs with step-by-step descriptions.

The 8569A is a general purpose microwave spectrum analyzer with a microprocessor-controlled digital display. Transfer of digital trace data and CRT labels, sweep control, and output from the analyzer of front panel control settings can be accomplished over the Hewlett-Packard Interface Bus (HP-IB)*. When used with a 9825 controller, the spectrum analyzer is capable of automatic data logging or interactive semi-automatic operation involving an operator.

Related Documents

Complete operating information for the 8569A Spectrum Analyzer can be found in:

1. 8569A Spectrum Analyzer Operation (P/N 08569-90008)
2. 8569A/0000-2 Quick Reference Guide (P/N 5952-9359)
3. 8569A Spectrum Analyzer Pull-Out Information Card

Information on operating the 9825 Desktop Computer can be found in:

1. HP 9825 Desktop Computer Operating and Programming Reference (P/N 09825-90200)
2. HP 9825 Desktop Computer I/O Control Reference (P/N 09825-90210)

A description of interface programming and hardware can be found in:

1. INTERFACING CONCEPTS and the 9825A (P/N 09825-90060)

Equipment Required

To perform the examples in this note, you will need the following equipment and accessories:

1. 8569A Spectrum Analyzer
2. 9825B Desktop Computer
3. 98034A HP-IB Interface

*Hewlett-Packard Interface Bus, the Hewlett-Packard implementation of instrument interface standard IEEE Std. 488-1978 and ANSI STD, MC 1.1, "Digital interface for programmable instrumentation."

Setup

Figure 1 shows the system connections and switch setting for the 98034A HP-IB Interface. To connect the system as shown, follow these steps:

1. Turn off power to the 8569A and 9825.
2. Install the 98034A in any available socket on the rear of the 9825. Be sure the 98034A seats securely in the socket; this has occurred when the latch on top of the interface pops up, locking the card into the socket.
3. Set the rotary switch located on top of the 98034A to position 7. Seven is the select code of the interface for all programs in this guide.
4. Connect the 24-pin connector at the free end of the 98034A cable to the rear panel of the 8569A (see Figure 1). This connector is shaped to ensure proper orientation.

CAUTION

Do not attempt to mate silver English threaded screws on one connector with black metric threaded nuts on another connector, or vice versa, as damage to the hardware may result. A metric conversion kit which will convert one cable and one or two instruments to metric hardware may be obtained by ordering HP P/N 5060-0138.

HP-IB Address

The analyzer's HP-IB address is determined by means of a rear-panel switch. Set the address to 18 by pressing switches 16 and 2 up and all others down:

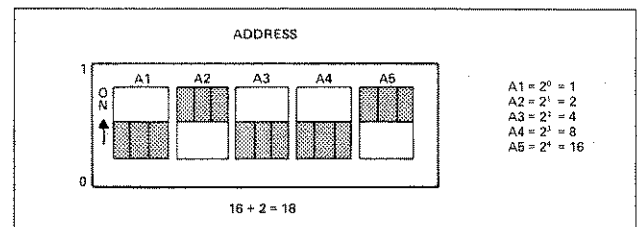

Check-out

After making AC power line connections to the analyzer and desktop computer, switch them on. Upon LINE ON, both devices perform internal test routines. When ready, the controller will display the "lazy T":



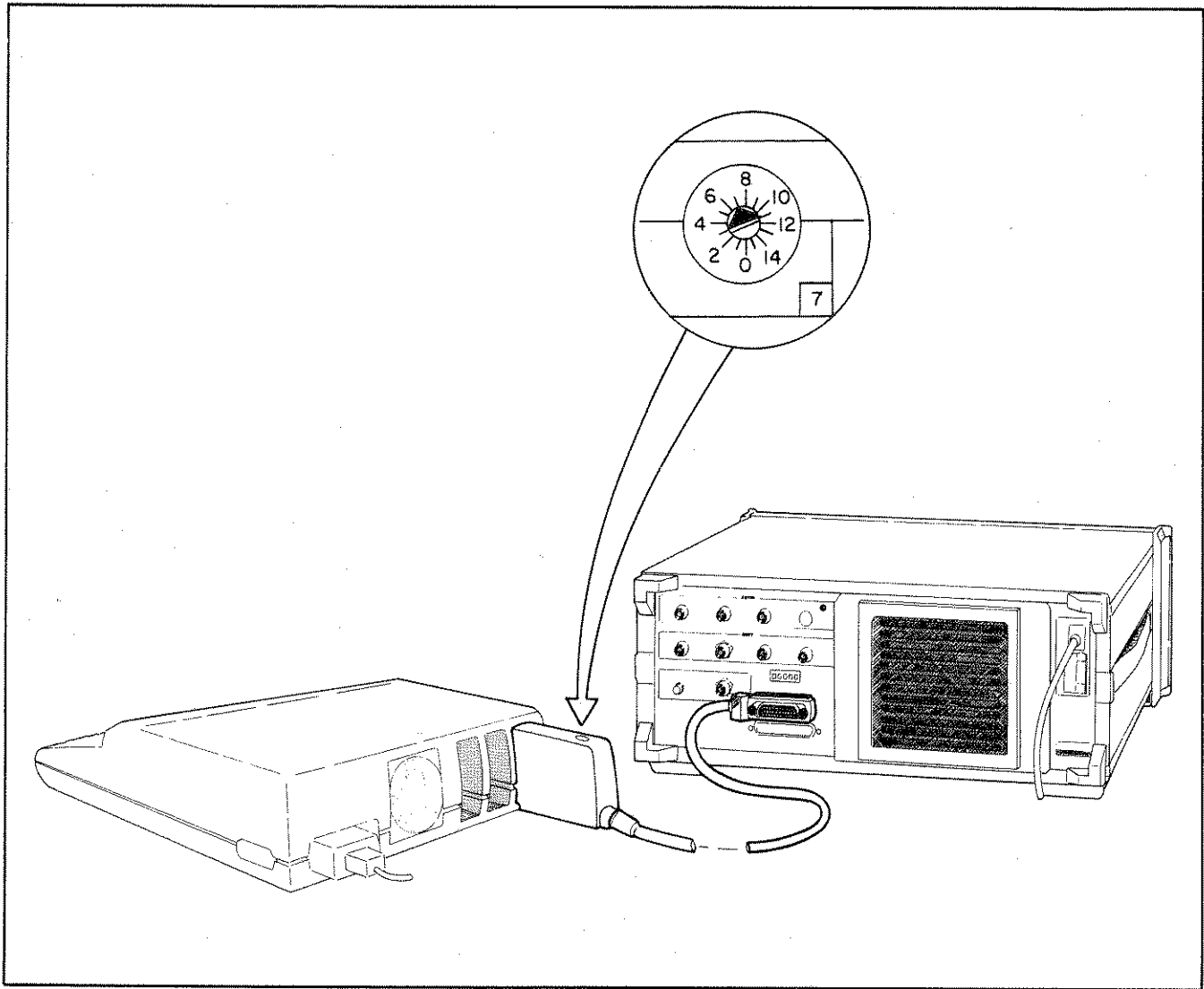

Figure 1. System connection.

If the calculator is turned on and the display is blank:

Press **CLEAR** or **STOP**

If the display remains blank, first check the power connection and fuse. If you still have a problem, call your HP sales and service office.

When the analyzer has completed a digital circuitry test routine it will be operating normally, with the control settings displayed above the graticule. In case a failure occurs, however, an error code will be displayed. Refer to the 8569A Operation and Service Manual for further information, or contact your HP sales and service office.

When both controller and analyzer are operating normally, type the following commands on the controller keyboard:

```
cli 7 [Press EXECUTE after each line]
wrt 718, "LUThis is a test!"
```

Upon execution of the second command, the analyzer should respond by displaying

This is a test!

on the upper line of annotation in place of the control settings which originally are displayed. If so, proceed to the programming examples. If the message does not appear, check to make sure that the 98034A select code is set to 7, the interface cables are properly connected, and the address in the wrt statement matches the address of the 8569A. Although 18 is the factory set address and the address used in the following examples, other addresses are possible.

If the message still does not appear on the CRT screen, consult the 8569A Operation and Service Manual, the 9825A/B System Test Booklet and the 98034A Installation and Service Manual for troubleshooting information.

Programming Examples

The following examples illustrate the entire command set of the 8569A when operated with a 9825 Desktop Computer.

The commands and their examples are divided into four functional categories: Labeling, Reading Control Settings, Trace Data I/O, and Sweep Control. It is suggested that a user new to the system first work through the examples to familiarize himself with the various commands, and then refer back to this Introductory Operating Guide as needed when developing programs.

To enter one or more lines of code into the 9825 memory, key in one line at a time (without line numbers — these are added automatically) and press STORE. When all lines are entered, press RUN to execute the program. Refer to the HP 9825 Desktop Computer Operating and Programming Reference for details on basic keyboard editing. To enter a new program, first clear the memory by typing

```
erase a      [Press EXECUTE]
```

In case an illegal two-letter mnemonic is sent to the analyzer, (i.e., one which is not part of the 8569A command set), a message will appear on the analyzer's CRT:

```
SYNTAX ERROR
```

To remove the message, send the command AU or manually press CLEAR/RESET, holding it in until the annotation reverts back to the control settings mode.

LABELING

LL, LU

To display "This is the upper line," and "and this is the lower line!" on the two CRT alphanumeric lines:

```
0: wrt 718,"LUThis is the upper line,"
1: wrt 718,"LLand this is the lower
   line!"
```

or

```
0: wtb 718,"LUThis is the
   upper line,",10,"LLand
   this is the lower line!",10
```

Note that any integer from 0 to 31 will terminate the LU or LL labeling text; the 10 used above corresponds to a linefeed.

AL, AU

To return the upper line and then the lower line of annotation to the control settings mode in effect at analyzer power-on, use the following commands:

```
0: wrt 718,"AU"
1: wrt 718,"AL"
```

or together:

```
0: wrt 718,"AUAL"
```

CS

To access the control settings or LL,LU labels which appear on the CRT, enter the annotation into a 127-character string dimensioned in the controller*. The result is printed.

```
0: dim A#[127]
1: wrt 718,"CS"
2: red 718,A#
3: prt A#
```

Refer to the HP 9825 Desktop Computer Operating and Programming Reference for details on string manipulations.

READING CONTROL SETTINGS

CF, SP, RB, RL, AT, ST, DM, DG, NS, VF, LG

The eleven control settings accessible over the HP-IB can be obtained by entering the CS string and reading the values or flags from the appropriate substrings. However, it is generally simpler to obtain a single value through direct interrogation of the analyzer. The format is the same for all eleven control settings (the result is displayed):

```
0: wrt 718,"CF"
1: red 718,A
2: dsp A
```

The returned value, A, takes on the following meanings (any of the other ten mnemonics may substitute for CF in the first line of code):

CF: Center frequency in Hz,
= -50000000 to 22600000000

* Although there are only 126 characters available from the CRT annotation (63 per line), the 9825 controller requires an extra character to be dimensioned for internal overhead.

SP: Span,
 = 1000 to 500000000 for Hz/division
 = 0 for Zero Span
 = -1 for Full Span
 = -2 for 1.7-22 GHz Span

RB: Resolution bandwidth in Hz,
 = 100 to 3000000

RL: Reference level,
 = 60 to -112 for dBm
 = 167 to -5 for dB μ V*
 = 172 to -172 for relative level of center graticule in dB with INP-B—A ON

AT: RF input attenuation in dB,
 = 0 to 70

ST: Sweeptime,
 = 2 to 10000000 for μ sec/division
 = -1 for AUTO sweeptime
 = -2 for MANual sweep
 = -3 for EXTernal sweep

DM: Detection mode = 0 for PEAK
 = 1 for SAMPLE

DG: Display mode = 0 for Normal
 = 1 for Digital Average

NS: Normalize state = 0 for INP-B—A OFF
 = 1 for INP-B—A ON

VF: Video filter,
 = .3 to .003 for ratio of VF to Res BW
 = -1 for VF 1 Hz (noise average)
 = -2 for VF OFF

LG: Amplitude scale,
 = 10, 5, 2, or 1 for LOG scale (dB/division)
 = 0 for LINEAR scale

TRACE DATA I/O

TA, TB, BA, BB

Speed, storage requirements, and programming convenience dictate the choice of trace output techniques, i.e., how best to utilize TA, TB and BA, BB.

*To convert to dB μ V, see Appendix D of 8569A Spectrum Analyzer Operation.

To transfer a trace from the analyzer into a numeric array, required for further processing, Method I is the fastest at 1.51 sec and requires the smallest amount of array storage (8 x 481 = 3848 bytes):

```
0: dim A[0:480]
1: wrt 718, "TA"
2: for I=0 to 480
3: red 718, A[I]
4: next I
```

METHOD I (Transfer to numeric array)

The array is dimensioned from 0 to 480 (481 total bytes). The TA command is sent, and a trace value is entered into the array for each increment in the for/next loop counter. All 481 values must be read into the controller to release the analyzer so that it can resume normal operation.

If immediate numerical processing is not required, other choices are more appropriate.

Method II is especially convenient when a trace is transferred to the controller, stored temporarily in memory or on a mass-storage medium, then recalled back to the analyzer's CRT through the use of the IA or IB command.

```
0: dim A#[1924]
1: wrt 718, "TA"
2: red 718, A#
3:
4:
5:
6: wrt 718, "IA", A#
```

METHOD II (TA, IA combination)

This requires only 1924 bytes of array storage but involves data only in string form which cannot be used in numerical calculations without prior conversion. The trace transfer time with TA (out of the analyzer) is about 300 msec and with IA (into the analyzer) about 170 msec.*

* See IA, IB for further details on the use of these commands.

For the fastest possible transfer out of the analyzer for temporary storage and subsequent numerical processing, Method III is the clear choice. Transfer from the analyzer of the full trace is achieved in 93 msec and the required array storage, 978 bytes, is minimal. The trade-off is that eventual processing will require a 2.7 sec conversion routine to produce a usable numeric array. This procedure must take place at some later time when speed is no longer at a premium.

```
0: dim A$(978);buf "Input",A$,3
1: wrt 718,"BA"
2: buf "Input";tfr 718,"Input",962
3: jmp rds("Input")=962
```

METHOD III (Rapid trace transfer for storage)

A\$ is dimensioned 16 characters or bytes more than are transferred; i.e., 2 bytes/value x 481 values + 16 bytes = 978 bytes. The buffer statement (buf) allocates and names a buffer (in this case "Input") in memory. After addressing the analyzer and sending the BA command in line 1, the buffer is initialized and the transfer is begun in line 2. While the transfer is in progress, the buffer status = 0. When the transfer is complete, the status = 962, the buffer size. Therefore, line 3 keeps the controller from continuing until the transfer is complete.

Refer to the HP 9825 Desktop Computer Extended I/O Programming manual for details of the buffered transfer technique.

The trace data stored in the "Input" buffer is accessible as a string (A\$) for storage. When recalled for numerical processing purposes, the following routine will convert the string A\$ into the numeric array B:

```
4: dim B[0:480]
5: for I=0 to 480
6: 2I+1>J
7: 256num(A$[J])+num(A$[J+1])>B[I]
8: next I
```

NOTE: } is -- on 9825 keyboard

Two 8-bit bytes are required to specify the full range, 0 to 820, of the digital CRT display: The first byte carries the 2 most significant bits, and the second byte carries the 8 least significant bits. To combine a pair of bytes into a single numeric value, it is necessary to read two bytes at a time from the buffer, shift the first by 8 bits to the left and add it to the second byte.

IA, IB

The IA or IB command allows the controller to output up to 481 values into trace A or trace B. Values in the range 1 to 975 are displayed at the corresponding levels on the CRT; 0 values are blanked. These commands are useful for re-entering trace data which have been previously output with TA or TB and stored (see Method II above) or for inputting an externally generated "trace", such as a test limit line stored in trace A to be superposed on real swept trace data viewed in trace B.

To generate a horizontal line 1/2 the width of the graticule at a level halfway up the screen, enter the following code (trace A should be STORE VIEW):

```
0: wrt 718,"IA"
1: for I=1 to 240
2: wrt 718,400,", "
3: next I
4: wrt 718,";"
```

After transmitting the IA instruction to the analyzer, display values (in this case all equal to 400) are input one at a time, each followed by an ASCII literal comma. To signal that the 241st value (I=240) is the last to be transmitted, a final semi-colon is sent to the analyzer. The semi-colon and the comma are optional following the 481st value when a full trace is input.

A shorter trace transfer time may be achieved by transmitting a single string variable rather than a series of individual numeric values:

```
0: dim A$[1206];fxd 0
1: for I=0 to 240
2: A$&str(400)&",">A$
3: next I
4: A$&";">A$
5: wrt 718,"IA",A$
```

In the first line, A\$ is dimensioned for 1206 characters, which is sufficient for 241 values. To estimate the required number of characters, multiply the number of values by 5, and add 1. ($241 \times 5 + 1 = 1206$) This allows up to 3 characters per value in the range 0 to 975 plus a leading blank generated by the str (string) function, a comma after each value, and one extra character for the final semi-colon. The fxd 0 instruction following the dimension statement insures that str will convert only the integer portion of a value into ASCII characters.

For each cycle of the for/next loop, the value 400 is converted to a literal string with str, concatenated to the current A\$, and a comma is then concatenated to this new string. The result becomes the new A\$. In line 4, a semi-colon is concatenated onto A\$ to provide a termination.

The transfer itself occurs in the last line. The mnemonic IA is output to the analyzer to signal a trace transfer, and A\$ is sent.

The total time needed to execute this version is longer than the first; the time advantage is only in transferring the string itself.

AP, BP

Frequently, only one data point is required, the peak response on the display out of the total 481 values. In order to obtain the x- and y-axis coordinates (0 to 480, 0 to 820) of this maximum, use the AP or BP command for trace A or trace B, respectively. If there is more than one response at the peak level, the left-most will be returned following the command:

```
0: wrt 718, "AP"
1: rdb 718, X, Y
2: dsp X, Y
```

SWEEP CONTROL

An important capability for a remotely controlled analyzer is to trigger a sweep. The two commands which are used to initiate sweeps with an 8569A may be used whether the analyzer is in single or continuous sweep mode.

It is especially important to take a sweep after changing a control setting or the analyzer input. This will insure that the current trace data corresponds to the current control settings and signal input.

TS

The TS command triggers a new sweep and inhibits subsequent commands to the analyzer until that sweep is complete. Upon completion, the analyzer resumes normal operation.

To understand how to use TS, consider the following example:

```
0: wtb 718, "TS"
1: dsp "Displays immediately."
2: wrt 718, "LUHo display until
   end-of-sweep."
```

Set the Sweeptime to 0.5 sec/div and RUN this code. Upon receipt of TS, the analyzer initiates a sweep. Immediately following this, and well before the sweep is complete, the message in line 1 appears on the 9825 LED display. On the other hand, the message on line 2, to be displayed on the analyzer's CRT, appears only after the end-of-sweep.

If wrt were to be substituted for wtb in line 0, the 9825 would attempt to transmit the usual terminating CR and LF after the ASCII characters TS. As these cannot be accepted until the analyzer has completed its sweep, line 1 (representing all other controller and non-analyzer bus activity) will not be executed until after the end-of-sweep occurs. To allow the possibility of other activity occurring for the duration of the sweep, the use of wtb is required with the TS command.

SF, MS Sweep with Flag, Mid-Sweep flag

At other times, it is desirable to trigger a sweep, permit the controller to execute other code, and then branch back to the analyzer after the sweep is complete. The intervening code might be data processing in the controller or even another measurement with different instruments on the interface bus. The Sweep with Flag (SF) command allows this end-of-sweep branching control, in conjunction with the Mid-Sweep (MS) flag.

```
0: wrt 718, "SF"
1: wrt 718, "MS"
2: rdb(718)>A
3: if not A; gto 20
4:
   • Program code to be executed while
   • analyzer is sweeping
   •
18:
19: gto 1
20: wrt 718, "AP"
21: rdb 718, X, Y
22: dsp X, Y
```

After triggering a sweep with the Sweep with Flag command (SF), Mid-Sweep flag (MS) is tested immediately. If the flag = 1 then the sweep is still in progress. At this point the controller executes the intervening code, then returns to line 1 with the gto command in line 19. This test and execute cycle is repeated until the flag = 0 signaling the end-of-sweep condition. The program then branches to line 20 where in this case the peak coordinates are output from the analyzer.

EXAMPLE APPLICATION PROGRAM

Several 8569A programming capabilities are illustrated in a harmonic distortion measurement program. This program measures the frequency and amplitude of an oscillator connected to the RF INPUT of an 8569A Spectrum Analyzer, measures the amplitudes of the signal's 2nd and 3rd harmonics, and calculates and displays the total harmonic distortion. The oscillator frequency must be in the range 10 MHz to 600 MHz and the amplitude less than +30 dBm (the maximum input level to the

analyzer). When the program is entered and the checksum verified, it should immediately be stored on a minicartridge tape for permanent storage.

When the program is RUN, the operator is instructed on the 9825 LED display to

Display Fund, 2nd, 3rd Harm.

The operator should adjust the 8569A front panel controls to display the fundamental signal along with its 2nd and 3rd harmonics. The display ought to look something like this (trace A must be active, SPAN in PER DIVISION mode):

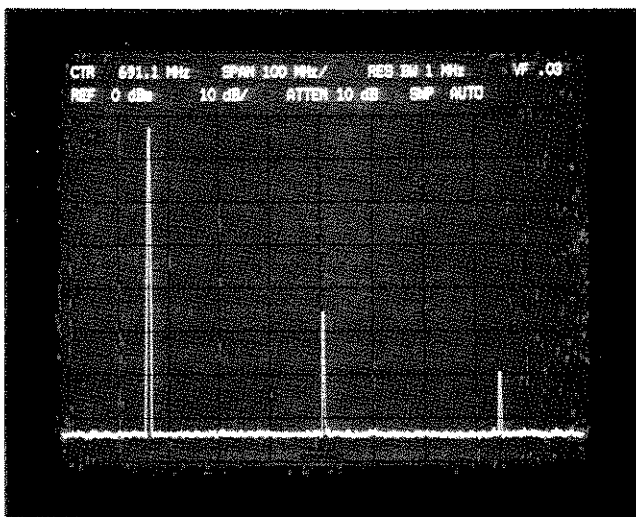

Be certain that all three signals to be measured are between the Reference Level and the 7th graticule (the display is not calibrated in the lowest vertical division). The largest signal on screen is assumed to be the fundamental — be sure to avoid the LO feedthrough!

When a satisfactory display has been acquired, set the SWEEP TRIGGER to SINGLE and press CONTINUE. The program will then commence its measurement. If all three signals are on screen as described above, after a few seconds the controller will print the results and label the analyzer CRT accordingly:

Fund	0.349 GHz	} 9825 Strip Printer Output
	-3.2 dBm	
2nd	-46.9 dBm	
3rd	-61.0 dBm	
	0.69% Dist	

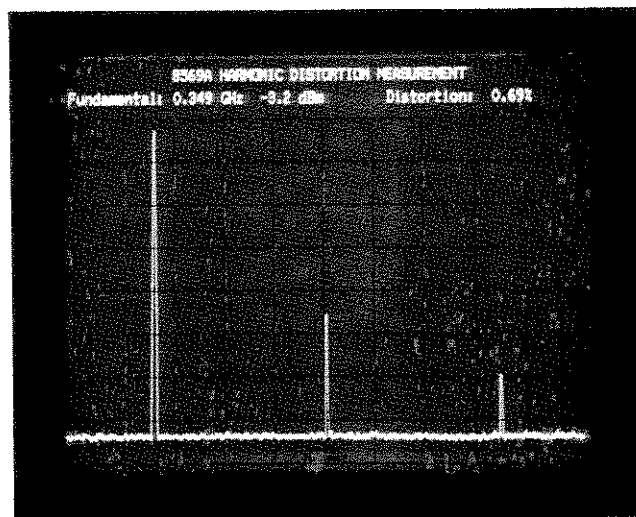

Measurement accuracy can be determined from the data sheet specifications for Reference Level and internal calibrator accuracies (absolute level); Log Display accuracy (relative level), and frequency calibration and display accuracy. Furthermore, as with all harmonic distortion measurements, consideration of the spectrum analyzer's gain compression, distortion products, and noise level (sensitivity) performance is essential, as well as knowledge of the test oscillator's frequency and amplitude stability. These measurement considerations are outside the scope of this Programming Note but are discussed in the Hewlett-Packard AN-150 series Application Notes.

The program listing follows, with a variable list and a description of the operation. When entering the program, follow the listing exactly to obtain the indicated checksum. Note that the symbol “}” which first appears on line 30 corresponds to “-” on the 9825 keyboard, and the “\” in line 61 is a “√”.

After the introduction in lines 0 to 7, a device statement in line 9 assigns the label “sa” to the analyzer's address, 718. The dimension statement assigns addresses to the various arrays including the T-array, indexed from 0 to 480 (481 total points). Lines 13-15 set standard controller formats, clear the interface bus and the analyzer, clear the CRT labeling, and trigger a sweep. In line 18, a message to the operator is displayed on the controller's LED display, and the stop command halts execution until CONTINUE is pressed on the keyboard.

Control settings are obtained in lines 21-24, following the programming example in the text. The scale factor is tested for 0 (LINEAR) which is not acceptable in later calculations; if this condition is true, a message is displayed and the program branches to the end statement in line 82.

The coordinates of the maximum response on trace A, assumed to represent the fundamental signal, are reported, and the measured level is verified to be below the Reference Level and above the 7th graticule line using the "On Screen?" subroutine.

Having acquired the current reference level (R), scale factor (B), center frequency (C), and span (S), the amplitude in dBm and frequency in Hz of the fundamental can be calculated (lines 30-31) from the display units obtained via the "AP" command. This frequency, in turn, determines the computed frequencies of the 2nd and 3rd harmonics and their corresponding x-axis positions in display units (lines 32-33). If the position of the 3rd harmonic is off screen, terminate execution.

Otherwise, the entire trace A is transferred into a numeric array (lines 36-39) and "windows" one division wide (48 points) centered on the calculated positions of the 2nd and 3rd harmonics are searched for local maxima, assumed to correspond to the 2nd and 3rd harmonic responses (lines 42-45 and lines 48-51).

A check for acceptable levels (lines 53-54) is followed by a conversion to absolute levels (lines 57-58).

Finally, the total distortion is calculated as the root sum of the squares normalized to the fundamental amplitude (line 61). Note that linear values, not log (dBm) values must be used in this calculation, so a function 'Lin' was defined in line 85 to perform the necessary conversion.

The results are printed on the 9825 strip printer (lines 64-69) and displayed on the analyzer's CRT using LU and LL commands (lines 72-77).

T	Trace A numeric array
A[1], A[2], A[3]	Amplitude of Fundamental, 2nd, 3rd (first in display units, then dBm)
X[1], X[2], X[3]	Position of Fundamental, 2nd, 3rd (display units)
L\$	String containing LU or LL message
C	Center frequency (Hz)
S	Span (Hz/div)
R	Reference level (dBm)
B	Scale factor (dB/div or 0 for LINEAR)
F	Fundamental frequency (Hz)
I	for/next loop counter
J	computed index in for/next loop
D	Distortion (%)

Variable List

```

0: "HARMONIC DISTORTION/8569A":
1: "9825: t0f0, 810121":
2: "This program measures the frequency and":
3: "amplitude of an oscillator connected to the":
4: "RF INPUT of an 8569A Spectrum Analyzer,":
5: "measures the amplitudes of the signal's 2nd":
6: "and 3rd harmonics, and calculates and":
7: "displays the total harmonic distortion.":
8:
9: "8569A":dev "sa",718
10:
11: dim T[0:480],A[3],X[3],L#[65]
12:
13: fmt ;fxd 2
14:
15: cli 7;clr "sa";wrt "sa","AUAL TS"
16:
17: "OPERATOR INSTRUCTIONS":
18: dsp "Display Fund, 2nd, 3rd Harm. ";stp
19:
20: "GET CONTROL SETTINGS":
21: wrt "sa","CF";red "sa",C
22: wrt "sa","SP";red "sa",S
23: wrt "sa","RL";red "sa",R
24: wrt "sa","LG";red "sa",B
25: if B=0;dsp "Use LOG scale, not LIN!";gto "End"
26: wrt "sa","AP";red "sa",X[1],A[1]
27: cli "On Screen?"(A[1])
28:
29: "CALCULATE FUND LEVEL, FREQ; HARM POSITIONS":
30: R-B(800-A[1])/100)A[1]
31: C+S(X[1]-240)/48)F
32: 48(2F-C)/S+240)X[2]
33: 48(3F-C)/S+240)X[3];if X[3]>480;gto "Err"
34:
35: "READ TRACE":
36: wrt "sa","TA"
37: for I=0 to 480
38: red "sa",T[I]
39: next I
40:
41: "FIND 2nd HARM":
42: -1)A[2]
43: for I=max(X[2]-24,0) to X[2]+24
44: if T[I]>A[2];T[I])A[2]
45: next I
46:
47: "Find 3rd HARM":
48: -1)A[3]
49: for I=X[3]-24 to min(X[3]+24,480)
50: if T[I]>A[3];T[I])A[3]
51: next I
52:
53: cli "On Screen?"(A[2])
54: cli "On Screen?"(A[3])
55:

```

Read Control
Settings:
CF, SP, RL, LG

Read Trace
Data: AP

Read Trace
Data: TA;
Load numeric
array

```

56: "CONVERT DISPLAY UNIT LEVELS TO DBM":
57: R-B(800-A[2])/100)A[2]
58: R-B(800-A[3])/100)A[3]
59:
60: "CALCULATE % DISTORTION":
61: 100\((Lin'(A[2])^2+Lin'(A[3])^2)/Lin'(A[1]))D
62:
63: "PRINT RESULTS":
64: prnd(F/1e9,-3)F;prnd(A[1],-1)A[1]
65: fmt 1,"Fund",f8.3," GHz";wrt 16.1,F
66: fmt 2,6x,f6.1," dBm";wrt 16.2,A[1]
67: fmt 3,"2nd",f9.1," dBm";wrt 16.3,prnd(A[2],-1)
68: fmt 4,"3rd",f9.1," dBm";wrt 16.4,prnd(A[3],-1)
69: fmt 5,/,4x,f6.2,"% Dist",3/;wrt 16.5,D
70:
71: "DISPLAY RESULTS ON CRT":
72: "LU      8569A ")L$
73: wrt "sa",L$&"HARMONIC DISTORTION MEASUREMENT"
74: fxd 3;"LLFundamental:"&str(F)&" GHz ")L$
75: fxd 1;L$&str(A[1])&" dBm")L$
76: fxd 2;L$&"      Distortion: "&str(D)&"%"L$
77: wrt "sa",L$;gto "End"
78:
79: "On Screen?":if p1>99 and p1<801;ret
80: "Err":dsp "Signals must all be ON SCREEN!"
81:
82: "End":end
83:
84: "FUNCTION 'Lin' CONVERTS DBM TO LINEAR":
85: "Lin":ret 10^(p1/20)
*14947

```

Write labels
on CRT: LU, LL

HP-IB COMMANDS

CONTROL SETTINGS

- CF:** Center frequency in Hz.
= - 50000000 to 22600000000
- SP:** Span,
= 1000 to 500000000 for Hz/division
= 0 for Zero Span
= -1 for Full Span
= -2 for 1.7-22 GHz Span
- RB:** Resolution bandwidth in Hz.
= 100 to 3000000
- RL:** Reference level,
= 60 to -112 for dBm
= 167 to -5 for dBμV*
= 172 to -172 for relative level of center graticule in dB with INP-B-A ON
- AT:** RF input attenuation in dB.
= 0 to 70
- ST:** Sweeptime,
= 2 to 10000000 for μsec/division
= -1 for AUTO Sweep
= -2 for MANUAL Sweep
= -3 for EXTERNAL Sweep
- DM:** Detection mode = 0 for PEAK
= 1 for SAMPLE
- DG:** Display mode = 0 for Normal
= 1 for Digital Average
- NS:** Normalize state = 0 for INP-B-A OFF
= 1 for INP-B-A ON
- VF:** Video filter,
= .3 to .003 for ratio of VF to Res BW
= -1 for VF 1 Hz (noise average)
= -2 for VF OFF
- LG:** Amplitude scale,
= 10, 5, 2, or 1 for LOG scale (dB/division)
= 0 for LINEAR scale

*To convert to dBμV, see Appendix D of 8569A Spectrum Analyzer Operation.

LABELING

LL, LU: Up to 63 ASCII characters (see Table 1) input to lower line (LL), or upper line (LU), terminated with a linefeed

Table 1. 8569A Display Character Set

32*-63	!"#\$%&'()*+,-./0123456789:;<=>?
64-95	@ABCDEFGHIJKLMNPQRSTUVWXYZ[\]^_`
96-127	~`abcdefghijklmnopqrstuvwxyz{ }~*~

*Character 32 is a blank

- AL, AU:** Resets lower line (AL) or upper line (AU) annotation to control setting mode
- CS:** Outputs a 126-character string (see Table 1) which represents the 63-character upper and lower lines of annotation, terminated by a linefeed

TRACE DATA I/O

- TA, TB:** Outputs 481 trace values (000 to 820), 3 digits each separated by commas (1923 bytes total), terminated with a linefeed
- BA, BB:** Outputs 481 trace values in double-byte format (962 bytes total) e.g., 00000011 00110100 = 820 display units
- IA, IB:** Inputs up to 481 trace values in the range 0 to 975 (0 blanks trace) separated by commas, terminated with a semi-colon
- AP, BP:** Outputs peak coordinates (x,y) of trace A or trace B, terminated with a linefeed

SWEEP CONTROL

- TS:** Triggers sweep (inhibits analyzer from accepting further commands until sweep is complete)
- SF, MS:** Triggers sweep, sets MS flag = 1; end-of-sweep condition signaled by setting MS flag = 0

DIGITAL CRT DISPLAY COORDINATES

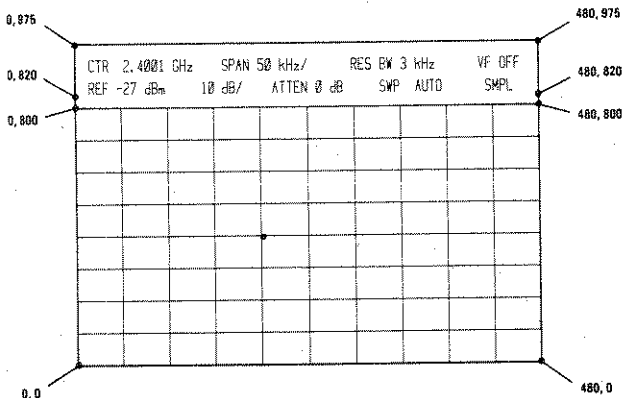

References to the CRT display coordinates (specifically, commands AP/BP, BA/BB, IA/IB, and TA/TB) will follow the layout in the above figure.

Within the range of the graticule, there are a total of 481 x-axis values (0 to 480, with 48 points per division) and 801 y-axis values (0 to 800, with 100 points per division). The y-axis overrange values displayed above the top of the graticule are 801 to 820 for the trace output commands AP/BP, BA/BB, and TA/TB, and 801-975 for the trace input commands IA/IB (values above 950 may be deflected off the top of the screen).

Two lines of annotation near the top of the CRT display are controlled by the commands CS, LL/LU, and AL/AU.

Supersedes: NONE

Introductory Operating Guide for the 8569A Spectrum Analyzer with the HP-85 Personal Computer

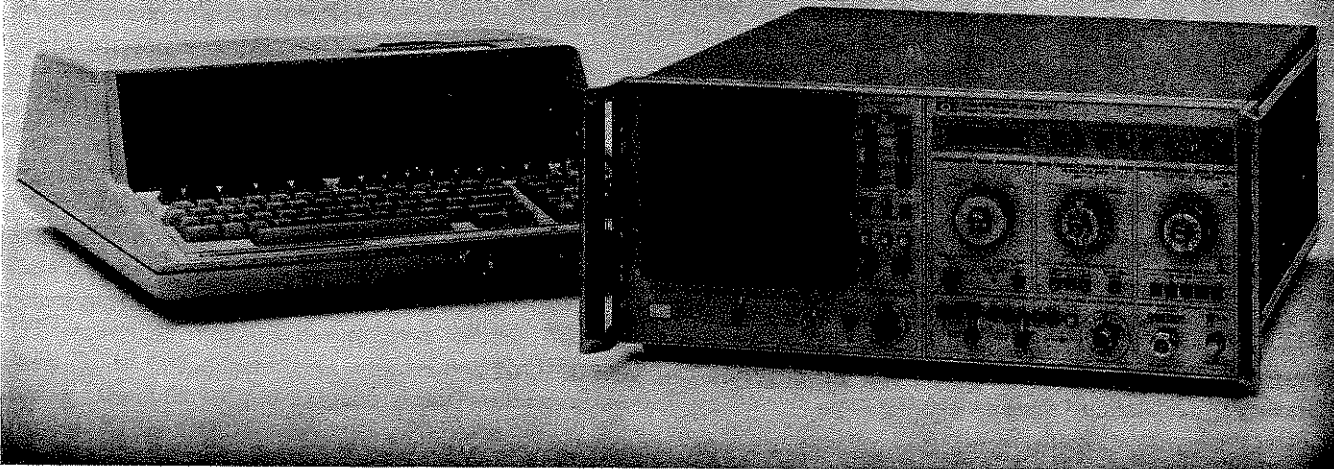

Introduction

This note is an introductory guide to remote operation and programming of the 8569A Spectrum Analyzer using an HP-85 Personal Computer. Included in this guide are system connections for remote operation and several example programs with step-by-step descriptions.

The 8569A is a general purpose microwave spectrum analyzer with a microprocessor-controlled digital display. Transfer of digital trace data and CRT labels, sweep control, and output from the analyzer of front panel control settings can be accomplished over the HP-IB*. When used with an HP-85 controller, the spectrum analyzer is capable of automatic data logging or interactive semi-automatic operation involving an operator.

Related Documents

Complete operating information for the 8569A Spectrum Analyzer can be found in:

1. 8569A Spectrum Analyzer Operation (P/N 08569-90008)
2. 8569A/0000-2 Quick Reference Guide (P/N 5952-9359)
3. 8569A Spectrum Analyzer Pull-Out Information Card

Information on operating the HP-85 Personal Computer can be found in:

1. HP-85 Owner's Manual and Programming Guide (P/N 00085-90002)
2. HP-85 I/O Programming Guide (P/N 00085-90142)

Information on the installation of the 92937A HP-IB Interface can be found in:

1. HP-IB Peripheral Installation Instructions (P/N 82937-90001)

Equipment Required

To perform the examples in this note, you will need the following equipment and accessories:

1. 8569A Spectrum Analyzer
2. HP-85F Personal Computer (includes 82936A ROM drawer, I/O ROM, and 82937A HP-IB Interface)

*Hewlett-Packard Interface Bus, the Hewlett-Packard implementation of instrument interface standard IEEE Std. 488-1978 and ANSI STD, MC 1.1, "Digital interface for programmable instrumentation".

Setup

Figure 1 shows the system connections. To connect the system as shown, follow these steps:

1. Turn off power to the 8569A and HP-85.
2. Install the I/O ROM into the 82936A ROM drawer, and insert the drawer into a socket on the rear of the HP-85.
3. Install the 82937A in any available socket on the rear of the HP-85. (The select code is factory set internally to 7.)
4. Connect the 24-pin connector at the free end of the 82937A cable to the rear panel of the 8569A (see Figure 1). This connector is shaped to ensure proper orientation.

CAUTION

Do not attempt to mate silver English threaded screws on one connector with black metric threaded nuts on another connector, or vice versa, as damage to the hardware may result. A metric conversion kit which will convert one cable and one or two instruments to metric hardware may be obtained by ordering HP P/N 5060-0138.

HP-IB Address

The analyzer's HP-IB address is determined by means of a rear-panel switch. Set the address to 18 by pressing switches 16 and 2 up and all others down:

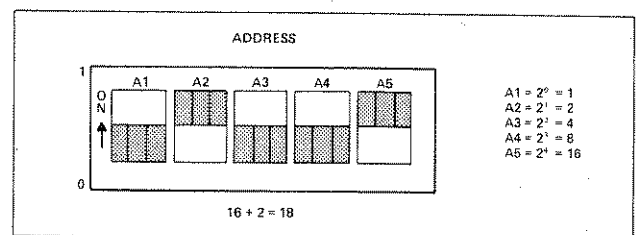

Check-Out

After making AC power line connections to the analyzer and desktop computer, switch them on. Upon LINE ON, both devices perform internal test routines. When ready, the controller will display an underscore as a cursor. If the self-test routine finds a problem, however, the HP-85 will beep and display:

Error 23: SELF TEST

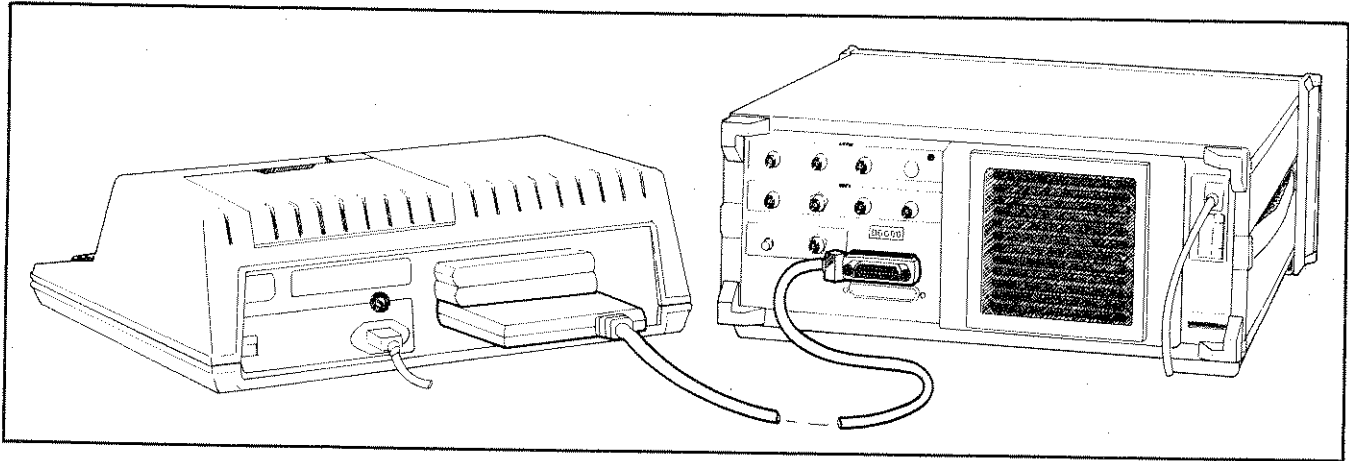

Figure 1. System connection.

This means that your controller is not operating properly; contact your nearest HP sales and service office.

When the analyzer has completed a self-test routine, it will be operating normally with the control settings displayed above the graticule. In case a fault is detected, however, an error code will be displayed. Refer to the 8569A Operation and Service Manual for further information, or contact your HP sales and service office.

When both controller and analyzer are operating properly, type the following commands on the controller keyboard:

```
ABORTIO 7 [Press END LINE after each line]
OUTPUT 718 ;"LUThis is a test!"
```

Upon execution of the second command, the analyzer should respond by displaying

```
This is a test!
```

on the upper line of CRT annotation in place of the control settings which are displayed at power-on. If so, proceed to the programming examples. If the message doesn't appear, check to be certain that the interface cable is properly connected, and the address in the OUTPUT statement matches the address of the 8569A. Although 18 is the factory set address and the address used in the following examples, other addresses are possible.

Programming Examples

The following examples illustrate the entire command set of the 8569A when operated with an HP-85 Personal Computer.

The commands and their examples are divided into four functional categories: Labeling, Reading Control Settings, Trace Data I/O, and Sweep Control.

It is suggested that a user new to the system first work through the examples to familiarize himself with the various commands, and then refer back to this Introductory Operating Guide as needed when developing programs.

To enter one or more lines of code into the HP-85 memory, press AUTO, then END LINE to instruct the controller to generate line numbers as code is entered. A

```
10 _
```

should appear. Enter at the keyboard one line of code (i.e., one logical line, which may extend beyond one 32 character CRT display line) and press END LINE. Then

```
20 _
```

will appear, and continue in this fashion until all lines are entered. If you wish to execute a sequence of lines stored in memory, add a terminating END statement. For example, if the last line of a program is numbered 80, add:

```
90 END
```

For details on basic keyboard editing, refer to the HP-85 Owner's Manual and Programming Guide.

To enter a new program, first clear the memory by typing:

```
[shift] RESET
[shift] SCRATCH [Press END LINE]
```

In case an illegal two-letter mnemonic is sent to the analyzer (i.e., one which is not part of the 8569A command set), a message will appear on the analyzer's CRT:

```
SYNTAX ERROR
```

To remove the message, send the command AU or manually press CLEAR/RESET, holding it in until the annotation reverts back to the control settings mode.

LABELING

LL, LU

To display "This is the upper line," and "and this is the lower line!" on the two CRT alphanumeric display lines:

```
10 OUTPUT 718 ; "LUThis is the up
per line,"
20 OUTPUT 718 ; "LLand this is th
e lower line!"
or
10 OUTPUT 718 ; "LUThis is the up
per line,↑LLand this is the low
er line!↑"
```

The ↑ is the HP-85 character representation of a linefeed and is entered from the keyboard using CTRL J.

Without explicit formatting, the HP-85 outputs a string in a free-field format with up to 20 trailing spaces. This means that considerable unnecessary traffic will be transmitted over the interface bus unless a precaution is taken. To eliminate these excess spaces, compact field formatting should be used, such as:

```
10 OUTPUT 718 USING "K" ; "LUNo
extra spaces!"
```

AL, AU

To return the upper line and then the lower line of annotation to the control settings mode in effect at analyzer power-on, use the following commands:

```
10 OUTPUT 718 ; "AU"
20 OUTPUT 718 ; "AL"
```

or together:

```
10 OUTPUT 718 ; "AUAL"
```

CS

To access the control settings or LL, LU labels which appear on the CRT, enter the annotation into a 126-character string dimensioned in the controller. The result is displayed.

```
10 DIM A#[126]
20 OUTPUT 718 ; "CS"
30 ENTER 718 ; A#
40 DISP A#
```

Refer to the HP-85 Owner's Manual and Programming Guide for details on string manipulations.

READING CONTROL SETTINGS

CF, SP, RB, RL, AT, ST, DM, DG, NS, VF, LG

The eleven control settings accessible over the HP-IB can be obtained by entering the CS string and reading the values or flags from the appropriate substrings. However, it is generally simpler to obtain a single value through direct interrogation of the analyzer. The format is the same for all eleven control settings (the result is displayed):

```
10 OUTPUT 718 ; "CF"
20 ENTER 718 ; A
30 DISP A
```

The returned value, A, takes on the following meanings (any of the other ten mnemonics may substitute for CF in the first line of code):

CF: Center frequency in Hz,
= -50000000 to 22600000000

SP: Span,
= 1000 to 500000000 for Hz/division
= 0 for Zero Span
= -1 for Full Span
= -2 for 1.7-22 GHz Span

RB: Resolution bandwidth in Hz,
= 100 to 3000000

RL: Reference level,
= 60 to -112 for dBm
= 167 to -5 for dB μ V*
= 172 to -172 for relative level of center graticule
in dB with INP-B→A ON

*See 8569A Spectrum Analyzer Operation, Appendix D to convert to dB μ V.

- AT:** RF input attenuation in dB,
= 0 to 70
- ST:** Sweeptime,
= 2 to 10000000 for μ sec/division
= -1 for AUTO sweeptime
= -2 for MANual sweep
= -3 for EXTernal sweep
- DM:** Detection mode = 0 for PEAK
= 1 for SAMPLE
- DG:** Display mode = 0 for Normal
= 1 for Digital Average
- NS:** Normalize state = 0 for INP-B-A OFF
= 1 for INP-B-A ON
- VF:** Video filter,
= .3 to .003 for ratio of VF to Res BW
= -1 for VF 1 Hz (noise average)
= -2 for VF OFF
- LG:** Amplitude scale,
= 10, 5, 2, or 1 for LOG scale (dB/division)
= 0 for LINEAR scale

TRACE DATA I/O

TA, TB, BA, BB

Speed, storage requirements, and programming convenience dictate the choice of trace output techniques, i.e., how to best utilize TA, TB and BA, BB.

To transfer a trace from the analyzer into a numeric array, required for further processing, Method I is essentially the fastest at 11.5 sec. The array storage requirement is 3366 bytes ($3 \times 481 + 1923 = 3366$).

```

10 DIM A$(1923)
20 INTEGER B(480)
30 OUTPUT 718 ; "TA"
40 ENTER 718 ; A$
50 FOR I=0 TO 480
60 J=4*I+1
70 B(I)=VAL(A$(J, J+2))
80 NEXT I

```

Method I
(Transfer into
numeric array)

String array A\$ is assigned a length of 1923 characters; the numeric array B is dimensioned as in INTEGER array to save storage space (3 bytes/value vs. 8 bytes/value).

The TA instruction is sent and the string A\$ transferred in lines 30-40. This string now must be converted to a numeric array of 481 values, accomplished in the FOR/NEXT loop in lines 50-80.

If immediate numerical processing is not required, other approaches are more suitable.

Method II is especially convenient when a trace is transferred to the controller, stored temporarily in memory or on a mass-storage medium, and recalled back to the analyzer's CRT through the use of the IA or IB command.

```

10 DIM A$(1923)
20 OUTPUT 718 ; "TA"
30 ENTER 718 ; A$
.
.
.
70 OUTPUT 718 ; "IA", A$

```

Method II
(TA, IA Combination)

This requires only 1923 bytes of array storage, but involves data only in string form which cannot be used in numerical calculations without prior conversion. The trace transfer time with TA (out of the analyzer) is 1.28 sec and with IA (into the analyzer), 0.70 sec.*

For the fastest possible transfer out of the analyzer for temporary storage and subsequent numerical processing, Method III is the clear choice. Transfer from the analyzer of the full trace is achieved in 170 msec and the required array storage, 970 bytes, is minimal. The trade-off is that eventual processing will require a 11.4 sec conversion routine to produce a suitable numeric array. This procedure must take place at some later time when speed is no longer at a premium.

```

10 DIM A$(970)
20 IOBUFFER A$
30 OUTPUT 718 ; "BA"
40 TRANSFER 718 TO A$ FHS

```

Method III
(Rapid trace transfer
for storage)

A\$ is dimensioned 8 bytes more than transferred, i.e., 2 bytes/value $\times 481 + 8$ bytes = 970 bytes. A\$ is designated an IOBUFFER (of working length 962). After sending a BA instruction in line 30, a Fast Hand-Shake (FHS) TRANSFER is accomplished in line 40.

* See IA, IB for further details on the use of these commands.

When it is necessary to convert A\$ into numeric data, the following code can be used:

```
50 INTEGER B(480)
60 FOR I=0 TO 480
70 J=2*I+1
80 B(I)=256*NUM(A#[J])+NUM(A#[J+
1])
90 NEXT I
```

Two 8-bit bytes are required to specify the full range, 0 to 820, of the digital CRT display: the first byte carries the 2 most significant bits, and the second byte carries the 8 least significant bits. To combine each pair of bytes from A\$ into a single numeric value, it is necessary to convert both string values to numeric values, multiply the first by $2^8=256$, and add it to the second.

IA, IB

The IA or IB command allows the controller to output up to 481 values into trace A or trace B. Values in the range 1 to 975 are displayed at the corresponding levels on the CRT; 0 values are blanked. These commands are useful for re-entering trace data which has been previously output with TA or TB and stored (see Method II), or for inputting an externally generated "trace", such as a test limit line stored in trace A to be superposed on real swept trace data viewed in trace B.

To generate a horizontal line $\frac{1}{2}$ the width of the graticule at a level half-way up the screen, enter the following code:

```
10 OUTPUT 718 ; "IA"
20 FOR I=0 TO 240
30 OUTPUT 718 ; 400, ", "
40 NEXT I
50 OUTPUT 718 ; "; "
```

After transmitting the IA instruction to the analyzer, display values (in this case all equal to 400) are input one at a time, each followed by an ASCII literal comma. To signal that the 241st value ($I=240$) is the last to be transmitted, a final semi-colon is sent to the analyzer. The semi-colon and the comma are optional following the 481st value when a full trace is input. This technique requires about 14.5 sec for the 241 values sent above.

It may be important in some cases to achieve the data transfer over the interface bus as rapidly as possible. The following method produces a fast transfer by transmitting the data as a single string variable rather than as a sequence of numeric values. The time required comes to 410 msec for 241 values. The trade-off comes, however,

if the string to be transferred must be "loaded" from numeric values, as is done below in lines 10-60. This procedure takes about 22.5 sec for 241 values:

```
10 DIM A#[965]
20 A#=""
30 FOR I=0 TO 240
40 A#=A#&VAL$(400)& ", "
50 NEXT I
60 A#=A#& "; "
70 OUTPUT 718 ; "IA", A#
```

In the first line, A\$ is dimensioned for 965 characters which is sufficient for 241 values. To estimate the required number of characters, multiply the number of values by 4, and add 1 ($241 \times 4 + 1 = 965$). This allows up to 3 characters and a comma per value in the range 0 to 975 plus one extra character for the final semi-colon. A\$ must then be assigned a null value prior to executing line 40 as required by the HP-85 controller.

For each cycle of the FOR/NEXT loop, the value 400 is converted to a literal string with VAL\$, concatenated to the current A\$, and a comma is then concatenated to this new string. The result becomes the new A\$. In line 60, a trailing semi-colon is concatenated onto A\$ to provide a termination.

The transfer itself occurs in the last line. The mnemonic IA is output to the analyzer to signal a trace transfer, and A\$ is sent.

AP, BP

Frequently, only one data point is required, the peak response on the display out of the total 481 values. In order to obtain the x- and y-axis coordinates (0 to 480, 0 to 820) of the maximum, use the AP or BP command for trace A or trace B, respectively. If there is more than one response at the peak level, the left-most will be returned following the command:

```
10 OUTPUT 718 ; "AP"
20 ENTER 718 ; X, Y
30 DISP X, Y
```

SWEEP CONTROL

An important capability for a remotely controlled analyzer is to trigger a sweep. The two commands which are used to initiate sweeps with an 8569A may be used whether the analyzer is in single or continuous sweep mode.

It is especially important to take a sweep after changing a control setting or the analyzer input. This will insure that the current trace data corresponds to the current control settings and signal input.

TS Take Sweep

The TS command triggers a sweep and inhibits subsequent commands to the analyzer until that sweep is complete. Upon completion, the analyzer resumes normal operation.

To understand how to use TS, consider the following example:

```
10 OUTPUT 718 USING "#,K" ; "TS"

20 DISP "Displays immediately."
30 OUTPUT 718 ; "LUNo display unt
41 end-of-sweep."
```

Set the Sweeptime to 0.5 sec/div and RUN this code. Upon receipt of TS, the analyzer initiates a sweep. Immediately following this, and well before the sweep is complete, the message in line 20 appears on the HP-85 CRT display. On the other hand, the message on line 30, to be displayed on the analyzer's CRT, appears only after the end-of-sweep.

If the USING "#,K" were to be omitted in line 10, the HP-85 would attempt to transmit the usual terminating CR and LF after the ASCII characters TS. As these cannot be accepted until the analyzer has completed its sweep, line 20 (representing all other controller and non-analyzer bus activity) will not be executed until after the end-of-sweep occurs. To allow the possibility of other activity occurring for the duration of the sweep, the use of USING "#,K" is required with the TS command.

SF, MS Sweep with Flag, Mid-Sweep flag

At other times, it is desirable to trigger a sweep, permit the controller to execute other code, and then branch back to the analyzer after the sweep is complete. The intervening code might be data processing in the controller or even another measurement with different instruments on the interface bus. The Sweep with Flag (SF) command allows this end-of-sweep branching control, in conjunction with the Mid-Sweep (MS) flag.

```
10 OUTPUT 718 ; "SF"
20 OUTPUT 718 ; "MS"
30 ENTER 718 USING "#,B" ; A
40 IF NOT A THEN 200
50
```

• Program code to be executed while
• analyzer is sweeping
•

```
180
190 GOTO 20
200 OUTPUT 718 ; "AP"
210 ENTER 718 ; X,Y
220 DISP X,Y
```

After triggering a sweep with SF in the first line, the MS flag is tested immediately. If the flag = 1 then the sweep is still in progress. At this point the controller executes the intervening code, then returns to line 20 with the GOTO command in line 190. This test and execute cycle is repeated until the flag = 0 signals the end-of-sweep condition. The program then branches to line 200 where in this case the peak coordinates are output from the analyzer.

EXAMPLE APPLICATION PROGRAM

Several 8569A programming capabilities are illustrated in a harmonic distortion measurement program. This program measures the frequency and amplitude of an oscillator connected to the RF INPUT of the spectrum analyzer, measures the amplitudes of the signal's 2nd and 3rd harmonics, and calculates and displays the total harmonic distortion. The oscillator frequency must be in the range 10 MHz to 600 MHz and the signal amplitude less than +30 dBm (the maximum allowed input to the analyzer). When the program is entered, it should immediately be stored on a minicartridge tape for permanent storage.

When the program is RUN, the operator is instructed on the HP-85 CRT to

Display Fund, 2nd, 3rd Harm.

The operator should adjust the 8569A front panel controls to display the fundamental signal along with its 2nd and 3rd harmonics. The analyzer CRT display ought to look something like this (trace A must be active, and SPAN in PER DIVISION mode):

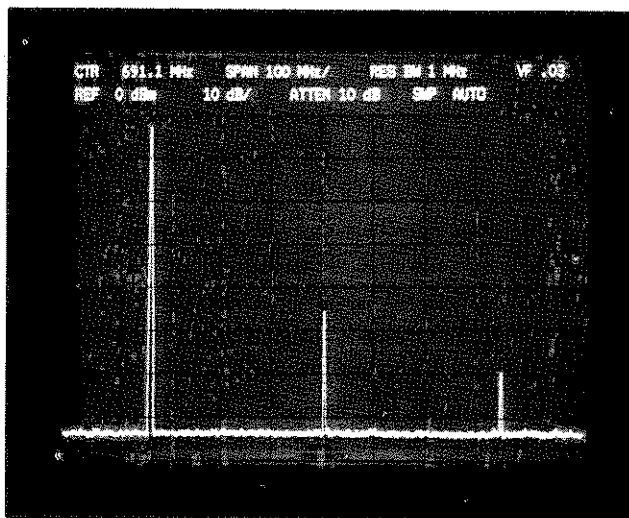

Be certain that all three signals to be measured are between the Reference Level and the 7th graticule (the display is not calibrated in the lowest division). The largest signal on screen is assumed to be the fundamental — be sure to avoid the LO feedthrough!

When a satisfactory display has been acquired, set the SWEEP TRIGGER to SINGLE and press CONTINUE on the HP-85. The program will then commence its measurement. If all three signals are on screen as described above, after a few seconds the controller will print the results and label the analyzer CRT accordingly:

```
Fund .349 GHz -3.2 dBm
2nd -46.9 dBm
3rd -61.0 dBm
Distortion .69 %
```

HP-85
Printer Output

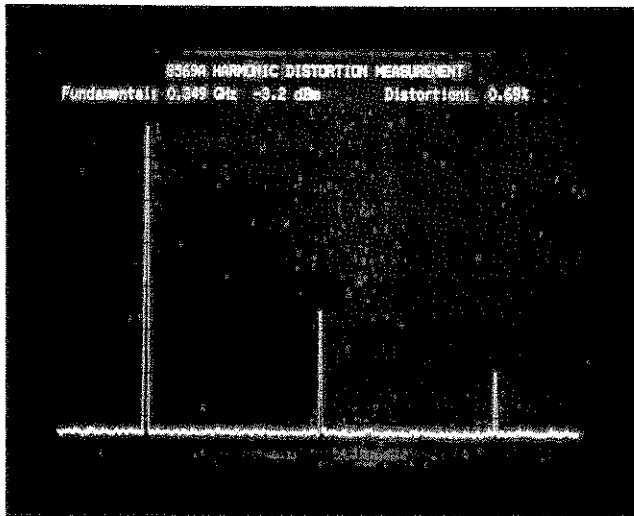

Measurement accuracy can be determined from the data sheet specifications for Reference Level and internal calibrator accuracies (absolute level), Log Display accuracy (relative level), and frequency calibration and display accuracy. Furthermore, as with all harmonic distortion measurements, consideration of the spectrum analyzer's gain compression, distortion products, and noise level (sensitivity) performance is essential, as well as knowledge of the test oscillator's frequency and amplitude stability. These measurement considerations are outside the scope of this Programming Note but are discussed in the Hewlett-Packard AN-150 series Application Notes.

The program listing follows, with a variable list and a description of the operation.

T\$	String which receives trace A data at transfer from analyzer
T	Trace A numeric array generated from T\$
A1, A2, A3	Amplitude of Fundamental, 2nd, 3rd (first in display units, then dBm)
X1, X2, X3	Position of Fundamental, 2nd, 3rd (display units)
C	Center frequency (Hz)
S	Span (Hz/div)
R	Reference level (dBm)
B	Scale factor (dB/div or 0 for LINEAR)
F	Fundamental frequency (Hz)
I	FOR/NEXT loop counter
J	Computed index in FOR/NEXT loop
D	Distortion (%)

Variable List

After the introduction in lines 1 to 12, the variable A is assigned the value 718 for subsequent use as the analyzer's address. The DIMENSION statement assigns 1923 bytes to T\$, and the INTEGER statement assigns $481 \times 3 = 1443$ bytes to the T-array. Line 19 clears the HP-85 CRT display, while lines 21-22 clear the interface bus, the analyzer, and the analyzer's CRT labeling, and then trigger a sweep. Note the use here of an "@" symbol to combine two separate commands onto a single line. Line 25 displays a message to the operator on the HP-85 CRT, and the PAUSE command halts execution until CONTINUE is pressed on the keyboard.

Control settings are obtained in lines 29-32, following the programming example in the text. The scale factor is tested for greater than 0 (i.e., LOG rather than LINEAR) which is required for computations; if this condition is not true (analyzer is in LINEAR mode), a message is displayed and the program branches to its termination.

The coordinates of the maximum response on trace A, assumed to represent the fundamental signal, are reported in lines 35-36, and the measured level is verified to be below the Reference Level and above the 7th graticule or else program execution is terminated.

Having acquired the current reference level (R), scale factor (B), center frequency (C), and span (S), the amplitude in dBm and frequency in Hz of the fundamental can be calculated (lines 40-41) from the display units obtained with the AP command. This frequency, in turn, determines the computed frequencies of the 2nd and 3rd harmonics and their corresponding x-axis positions in display units (lines 42-43). If the position of the 3rd harmonic is determined to be off screen, a message is displayed and the program terminated.

Otherwise, the entire trace A is transferred into the controller's memory as a string and converted to a numeric array (lines 47-52). In lines 55-58 and 61-64, "windows" one division wide (48 points) centered on the calculated positions of the 2nd and 3rd harmonics are searched for local maxima, assumed to correspond to the 2nd and 3rd harmonic responses.

Checks for acceptable levels (lines 66-67) are followed by conversions to absolute levels (lines 70-71).

Finally, in line 74 the total distortion is calculated as the root sum of the squares normalized to the fundamental amplitude. Note that linear values, not log (dBm) values must be used in this computation, so a function FNL was defined at the end of the program code to perform the necessary conversion.

The results are printed on the HP-85 after rounding (more user-defined functions FNR1-FNR3) in lines 77-83, and displayed on the analyzer's CRT using the LU and LL commands in lines 86-87.

```

1 | HARMONIC DISTORTION/8569A
2 | HP-85: HarDis (810126)
3 | This program measures the
4 | frequency and amplitude of
5 | an oscillator connected to
6 | the RF INPUT of an 8569A
7 | Spectrum Analyzer,
8 | measures the amplitudes of
9 | the signal's 2nd and 3rd
10 | harmonics, and calculates
11 | and displays the total
12 | harmonic distortion.
13 |
14 | A=718 | 8569A Address
15 |
16 | DIM T$(1923)
17 | INTEGER T(480)
18 |
19 | CLEAR
20 |
21 | ABORTIO 7 @ CLEAR A
22 | OUTPUT A ; "AU AL TS"
23 |
24 | OPERATOR INSTRUCTIONS
25 | DISP "Display Fund, 2nd, 3rd
26 | Harm." @ PAUSE
27 | DISP "RUNNING..."
28 |
29 | GET CONTROL SETTINGS
30 | OUTPUT A ; "CF" @ ENTER A ; C
31 | OUTPUT A ; "SP" @ ENTER A ; S
32 | OUTPUT A ; "RL" @ ENTER A ; R
33 | OUTPUT A ; "LG" @ ENTER A ; B
34 | IF B>0 THEN 35
35 | DISP "Use LOG scale, not LIN!"
36 | @ GOTO 92
37 |
38 | READ TRACE
39 | OUTPUT A ; "AP"
40 | ENTER A ; X1,A1
41 | IF A1<100 OR A1>800 THEN 90
42 |
43 | CALCULATE FUND LEVEL, FREQ;
44 | HARM POSITIONS
45 |
46 | A1=R-B*(800-A1)/100
47 | F=C+S*(X1-240)/48
48 | X2=48*(2*F-C)/S+240
49 | X3=48*(3*F-C)/S+240
50 | IF X3>480 THEN 90
51 |
52 | READ TRACE
53 | OUTPUT A ; "TA"
54 | ENTER A ; T$
55 | FOR I=0 TO 480
56 | J=4*I+1
57 | T(I)=VAL(T$(J,J+2))
58 | NEXT I
59 |
60 | FIND 2ND HARMONIC

```

Read Control
Settings:
CF, SP, RL, LG

Read Trace
Data: AP

Read Trace Data:
TA;
Load Numeric
Array

```

55 A2=-1
56 FOR I=MAX(X2-24,0) TO X2+24
57 IF T(I)>A2 THEN A2=T(I)
58 NEXT I
59 !
60 ! FIND 3RD HARMONIC
61 A3=-1
62 FOR I=X3-24 TO MIN(X3+24,480)
63 IF T(I)>A3 THEN A3=T(I)
64 NEXT I
65 !
66 IF A2<100 OR A2>800 THEN 90
67 IF A3<100 OR A3>800 THEN 90
68 !
69 ! CONVERT DISP UNITS TO DBM
70 A2=R-B*(800-A2)/100
71 A3=R-B*(800-A3)/100
72 !
73 ! CALCULATE % DISTORTION
74 D=100*SQR(FNL(A2)^2+FNL(A3)^2
)/FNL(A1)
75 !
76 ! PRINT RESULTS
77 F=FNR3(F/1000000000)
78 A1=FNR1(A1) @ A2=FNR1(A2) @ A
3=FNR1(A3) @ D=FNR2(D)
79 PRINT "Fund ";F;"GHz ";A1;"d
Bm"
80 PRINT "2nd ";A2;"dBm"
81 PRINT "3rd ";A3;"dBm"
82 PRINT "Distortion ";D;"%"
83 PRINT USING "3/,X"
84 !
85 ! DISPLAY RESULTS ON CRT
86 OUTPUT A ;"LU 856
9A HARMONIC DISTORTION MEASUREME
NT"
87 OUTPUT A ;"LLFundamental: "&V
AL$(F)&" GHz "&VAL$(A1)&" dBm
Distortion: "&VAL$(D)&"%"
88 GOTO 92
89 !
90 DISP "Signals must all be ON
SCREEN!"
91 !
92 CLEAR
93 END
94 !
95 !
96 DEF FNL(X) = 10^(X/20)
97 DEF FNR1(X) = INT(X*10+.5)/10
98 DEF FNR2(X) = INT(X*100+.5)/1
00
99 DEF FNR3(X) = INT(X*1000+.5)/
1000

```

Write labels
on CRT:
LU, LL

HP-IB COMMANDS

CONTROL SETTINGS

- CF:** Center frequency in Hz.
= - 50000000 to 22600000000
- SP:** Span.
= 1000 to 500000000 for Hz/division
= 0 for Zero Span
= -1 for Full Span
= -2 for 1.7-22 GHz Span
- RB:** Resolution bandwidth in Hz.
= 100 to 3000000
- RL:** Reference level.
= 60 to -112 for dBm
= 167 to -5 for dBμV*
= 172 to -172 for relative level of center graticule in dB with INP-B-A ON
- AT:** RF input attenuation in dB.
= 0 to 70
- ST:** Sweeptime.
= 2 to 10000000 for μsec/division
= -1 for AUTO Sweep
= -2 for MANual Sweep
= -3 for EXTernal Sweep
- DM:** Detection mode = 0 for PEAK
= 1 for SAMPLE
- DG:** Display mode = 0 for Normal
= 1 for Digital Average
- NS:** Normalize state = 0 for INP-B-A OFF
= 1 for INP-B-A ON
- VF:** Video filter.
= .3 to .003 for ratio of VF to Res BW
= -1 for VF 1 Hz (noise average)
= -2 for VF OFF
- LG:** Amplitude scale.
= 10, 5, 2, or 1 for LOG scale (dB/division)
= 0 for LINEAR scale

*To convert to dBμV, see Appendix D of 8569A Spectrum Analyzer Operation.

LABELING

LL, LU: Up to 63 ASCII characters (see Table 1) input to lower line (LL), or upper line (LU), terminated with a linefeed

Table 1. 8569A Display Character Set

32*-63	!"#\$%&'()*+,-./0123456789:;<=>?
64-95	@ABCDEFGHIJKLMNPQRSTUVWXYZ[\]^_
96-127	`abcdefghijklmnopqrstuvwxyz{ }~* *Character 32 is a blank

AL, AU: Resets lower line (AL) or upper line (AU) annotation to control setting mode

CS: Outputs a 126-character string (see Table 1) which represents the 63-character upper and lower lines of annotation, terminated by a linefeed

TRACE DATA I/O

TA, TB: Outputs 481 trace values (000 to 820), 3 digits each separated by commas (1923 bytes total), terminated with a linefeed

BA, BB: Outputs 481 trace values in double-byte format (962 bytes total) e.g., 00000011 00110100 = 820 display units

IA, IB: Inputs up to 481 trace values in the range 0 to 975 (0 blanks trace) separated by commas, terminated with a semi-colon

AP, BP: Outputs peak coordinates (x,y) of trace A or trace B, terminated with a linefeed

SWEEP CONTROL

TS: Triggers sweep (inhibits analyzer from accepting further commands until sweep is complete)

SF, MS: Triggers sweep, sets MS flag = 1; end-of-sweep condition signaled by setting MS flag = 0

DIGITAL CRT DISPLAY COORDINATES

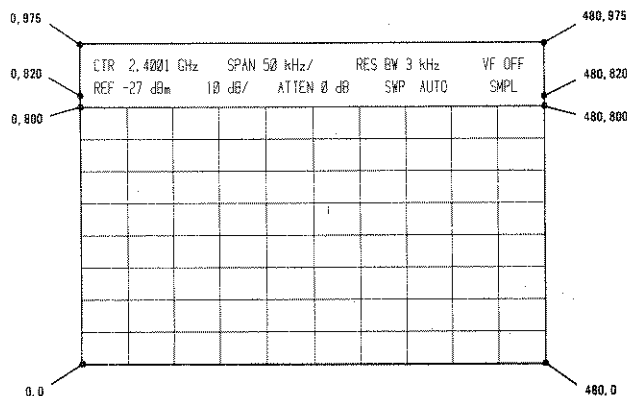

References to the CRT display coordinates (specifically, commands AP/BP, BA/BB, IA/IB, and TA/TB) will follow the layout in the above figure.

Within the range of the graticule, there are a total of 481 x-axis values (0 to 480, with 48 points per division) and 801 y-axis values (0 to 800, with 100 points per division). The y-axis overrange values displayed above the top of the graticule are 801 to 820 for the trace output commands AP/BP, BA/BB, and TA/TB, and 801-975 for the trace input commands IA/IB (values above 950 may be deflected off the top of the screen).

Two lines of annotation near the top of the CRT display are controlled by the commands CS, LL/LU, and AL/AU.